

BELL

INSTALLATION INSTRUCTIONS

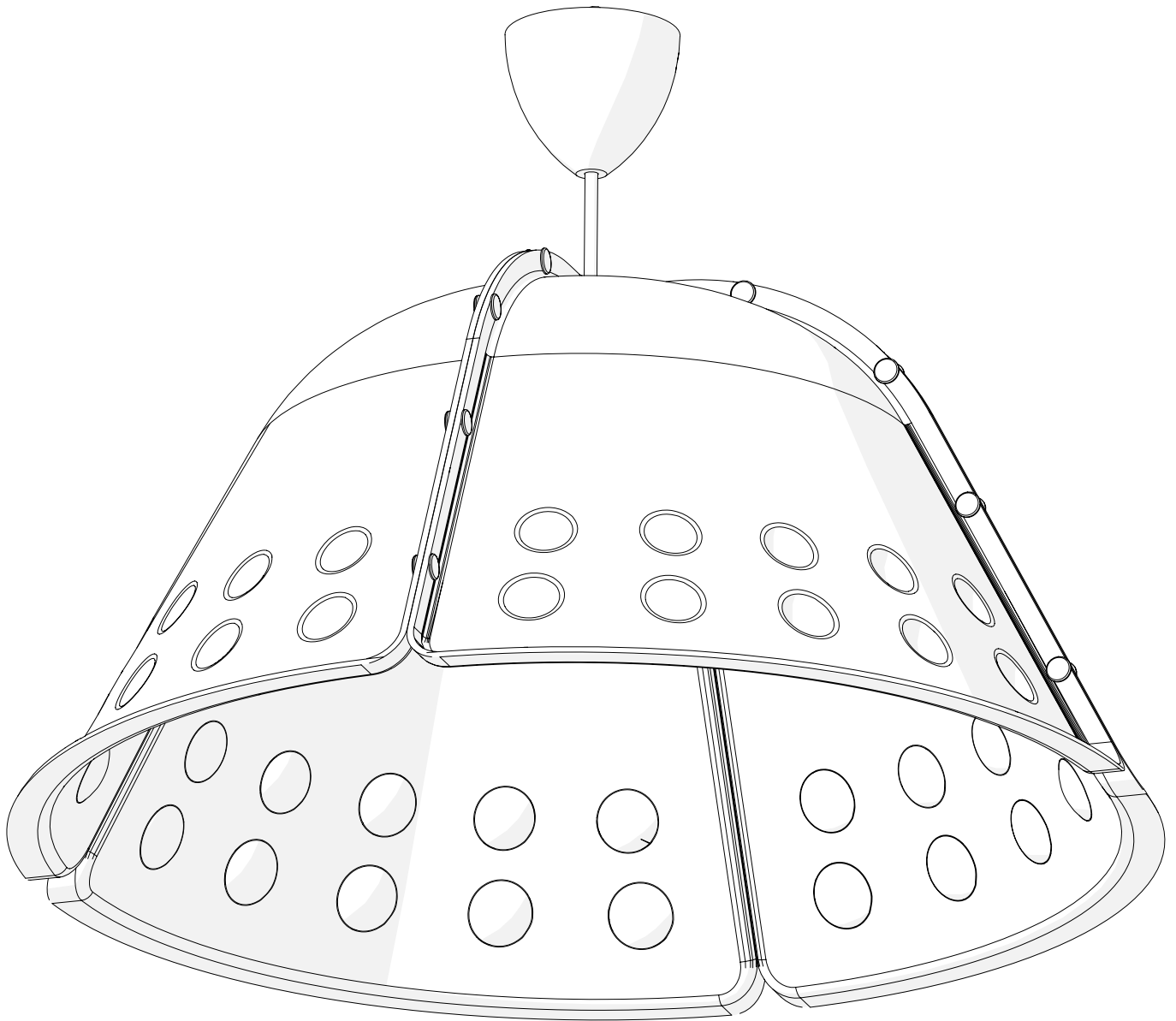

BELL: INCLUDED COMPONENTS

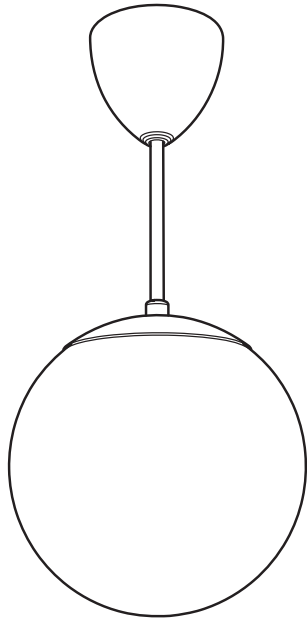

Light Assembly [x1]

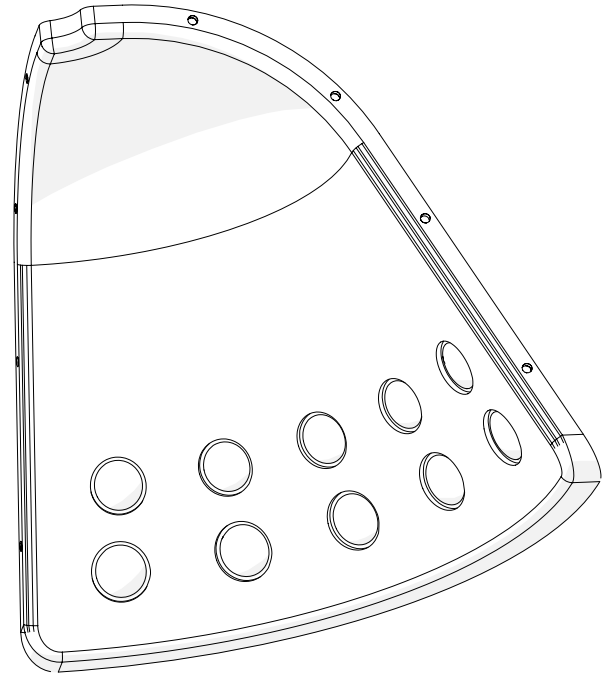

BELL quadrant [x4]

INCLUDED HARDWARE

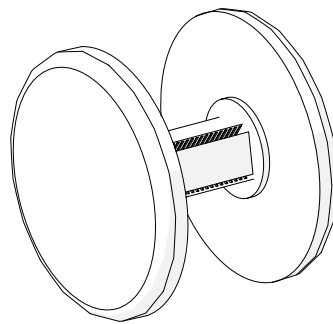

Snap Rivet [x16]

BELL: INSTALLATION INSTRUCTIONS

- 1 Assemble 2 quadrants with snap rivets as shown below. Repeat to assemble 2 halves of BELL.

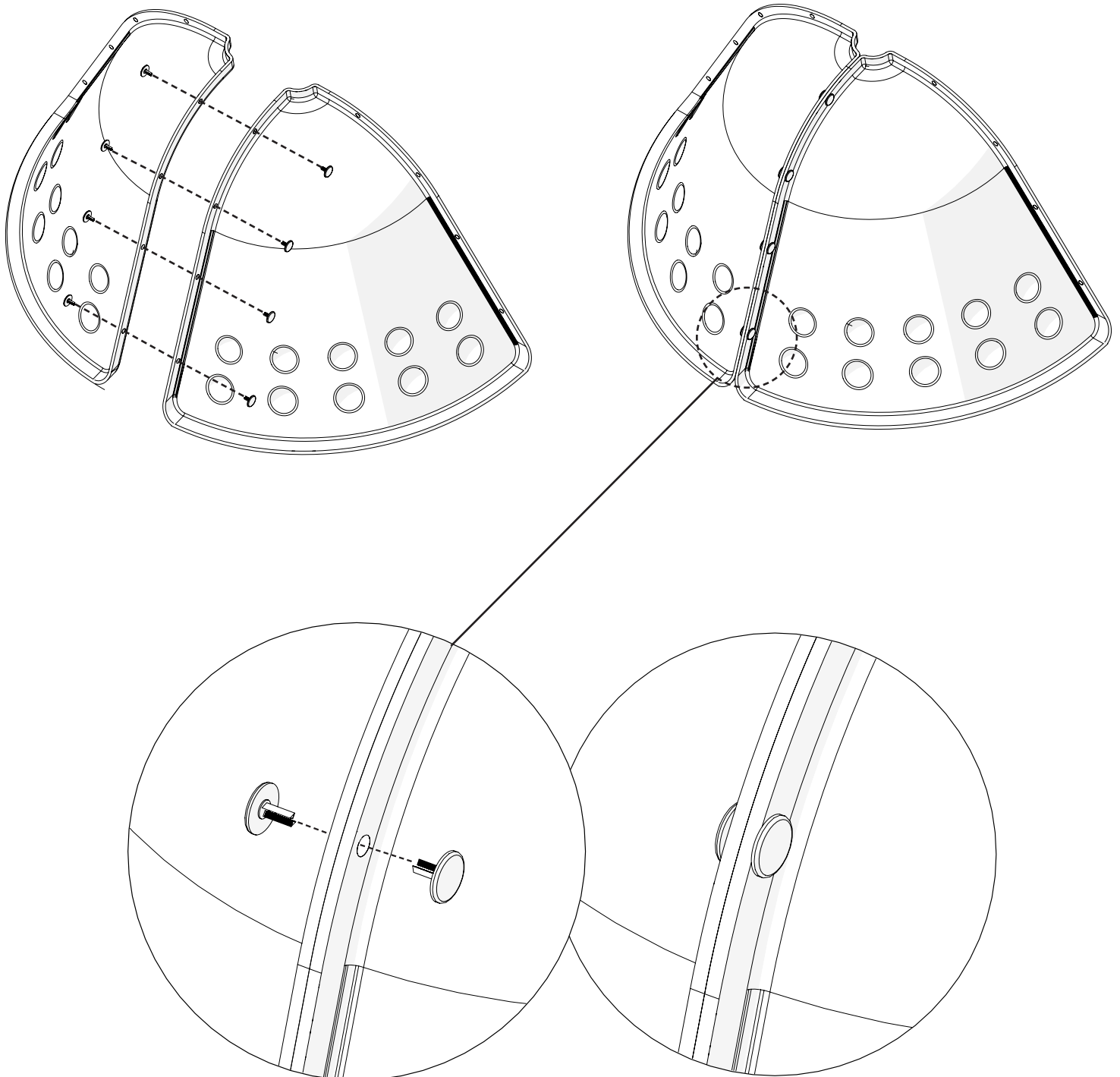

BELL: INSTALLATION INSTRUCTIONS

3 Assemble the 2 halves around the light fixture with snap rivets as shown below.

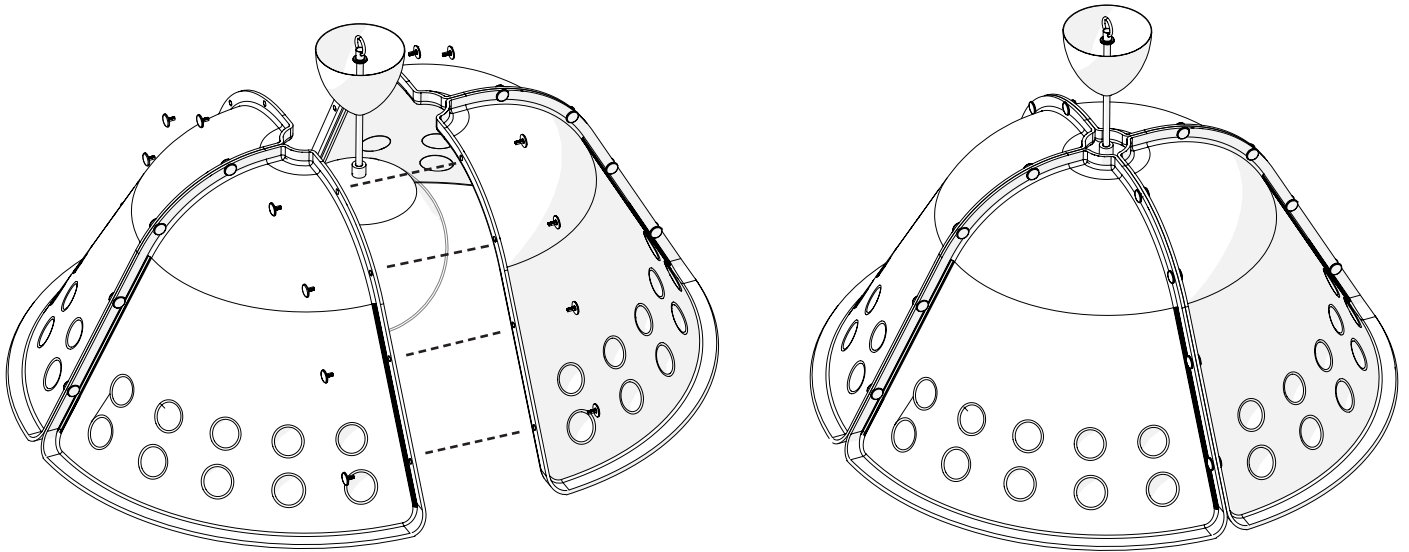

3 Hang BELL according to light fixture specifications.

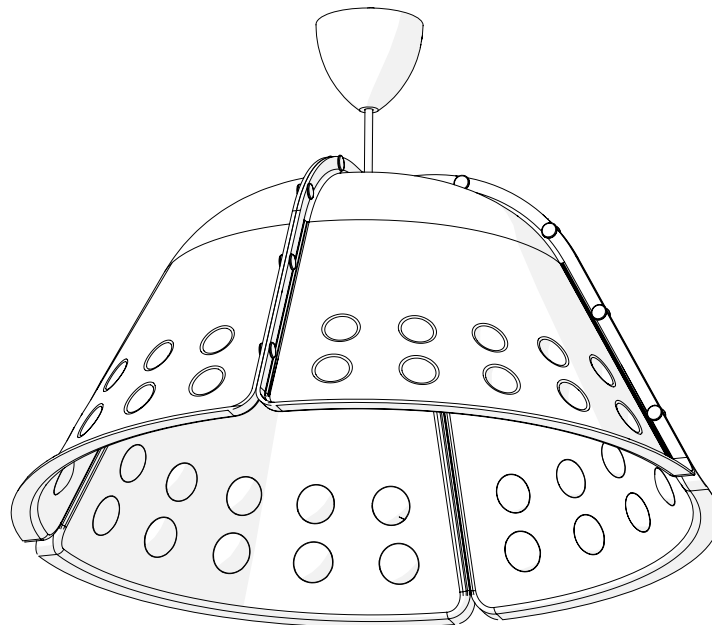

Installation complete.