

## NET: ASSEMBLY INSTRUCTIONS

### ACOUSTICAL BAFFLE

---

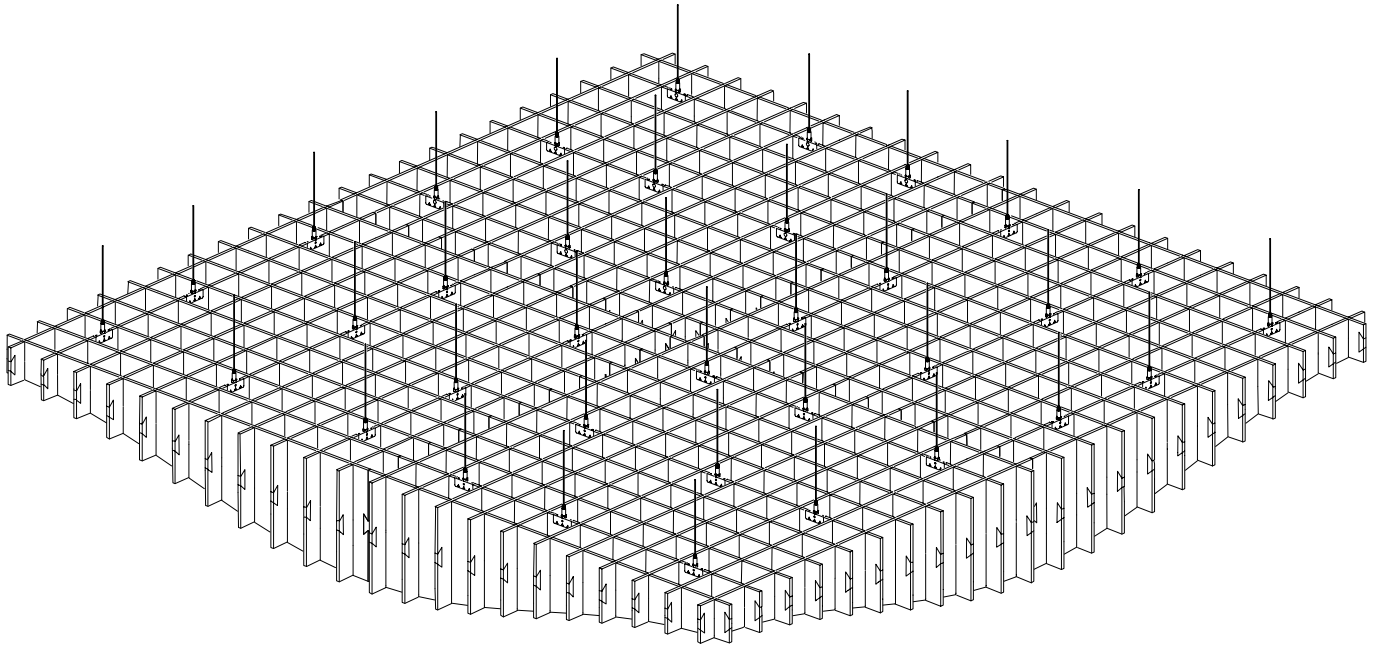

### TOOLS REQUIRED

---

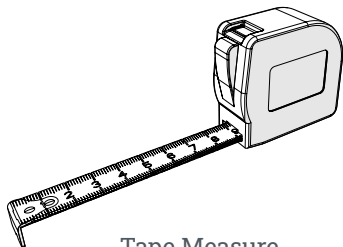

Tape Measure

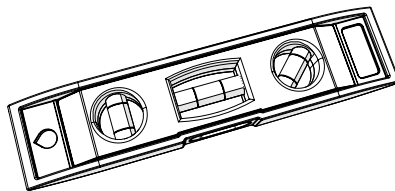

Level

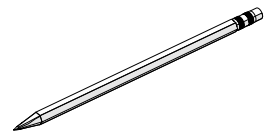

Pencil/Marker

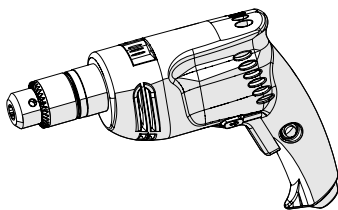

Power Drill

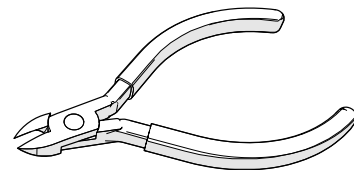

Wire Cutters

## NET: INCLUDED HARDWARE STANDARD HARDWARE

---

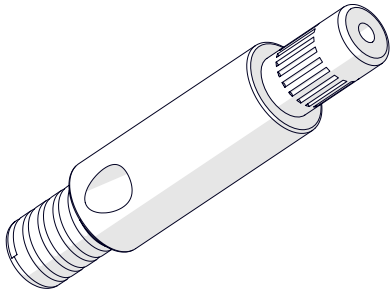

Standard Gripper [x9]

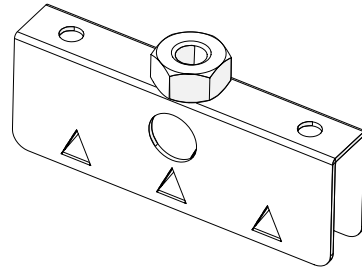

Spike Bracket [x9]

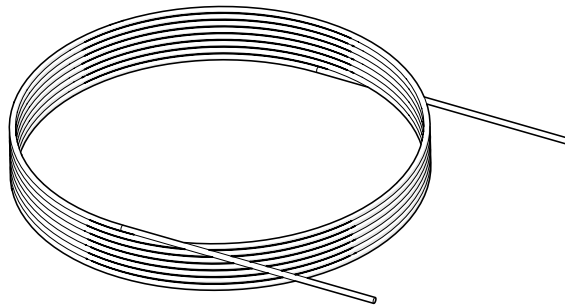

Aircraft Cable [13.5ft]

Hardware shown is for one (1) module. Finish installation shown on last page includes 4 joined modules.

Standard hardware shown does not include direct to ceiling, wall or floor hardware. All customers of Fräsch products are responsible for the selection of final surface mounting hardware.

Please contact [support@frasch.com](mailto:support@frasch.com) to review your unique site conditions and select the appropriate hardware package.

## NET: ASSEMBLY INSTRUCTIONS

### INCLUDED COMPONENTS

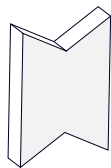
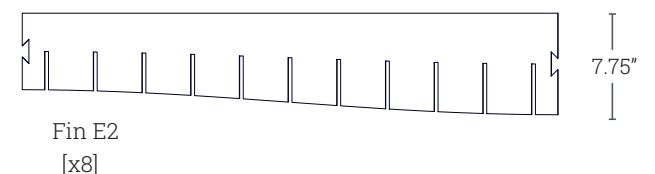
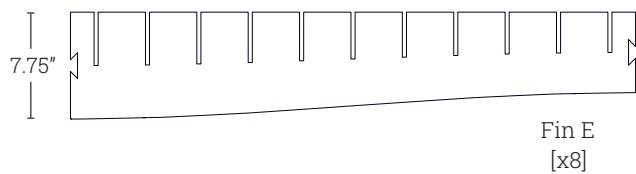
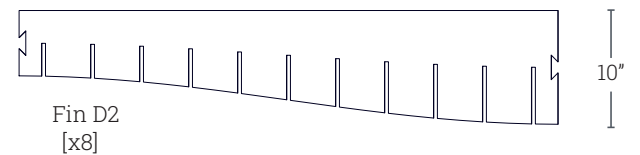
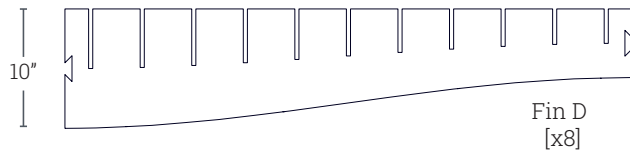
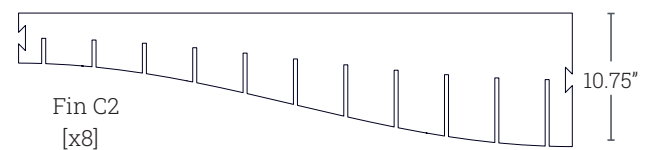
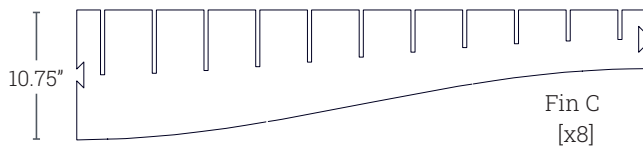
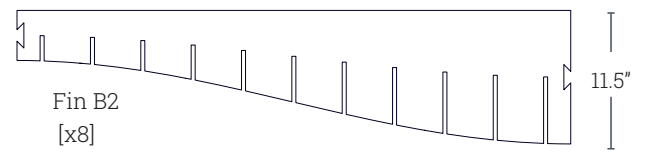
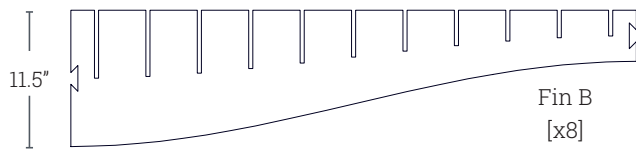
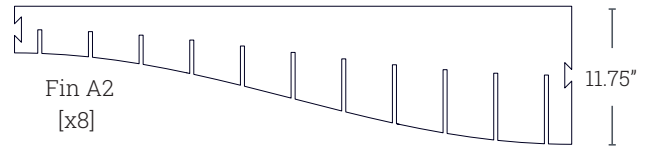
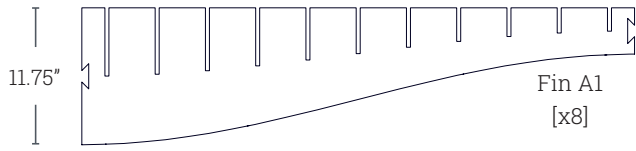

Bowtie Connector [x44]

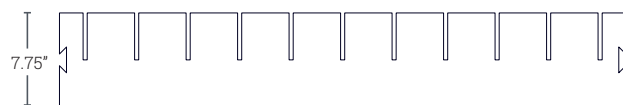

Fin F [CENTER]  
[x8]

## NET: ASSEMBLY INSTRUCTIONS

### MODULE RIB LAYOUT

NET shown at the end of this document is formed by 4 identical assemblies referred to as "modules". Once completed, the modules are hung one by one and the dovetail connector is installed at the seam of each connecting fin.

Refer to this diagram when assembling the modules.

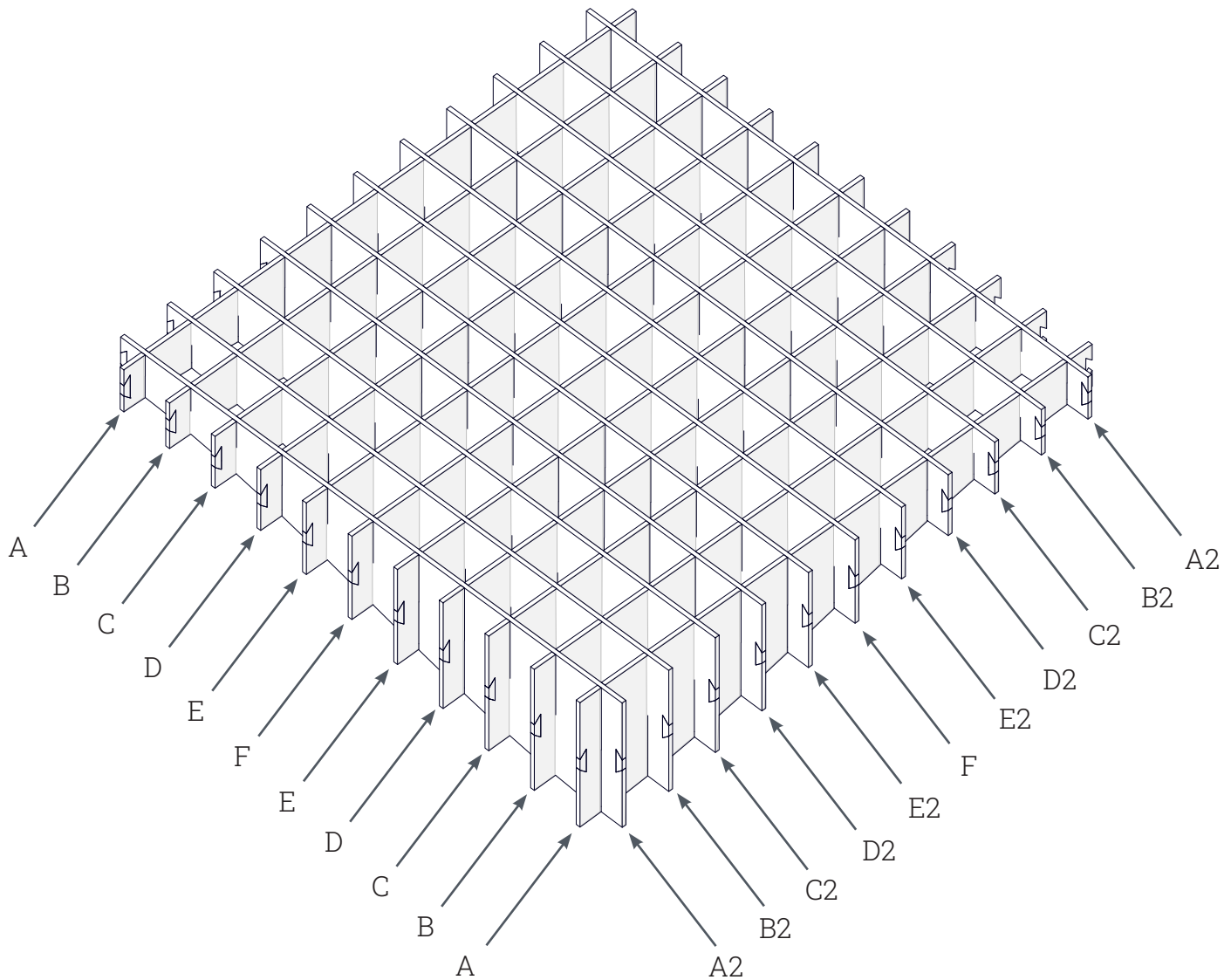

## NET: ASSEMBLY INSTRUCTIONS

### ASSEMBLING THE MODULE

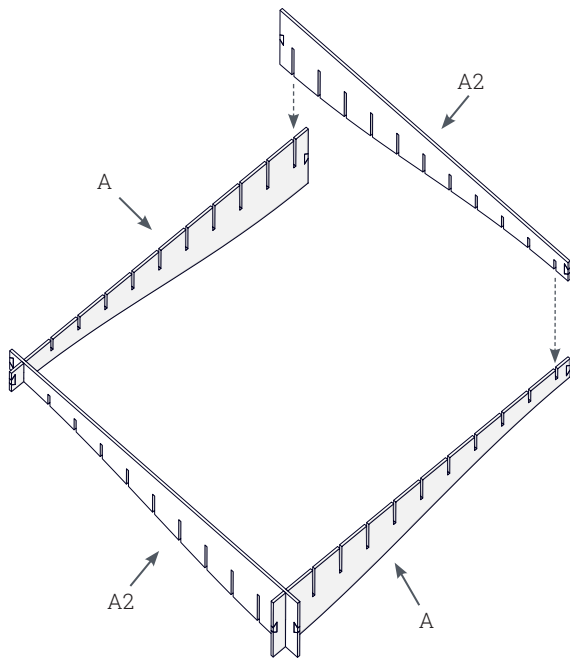

**Step 1:** Assemble a box frame of the first module with the 4 corresponding fins as shown above.

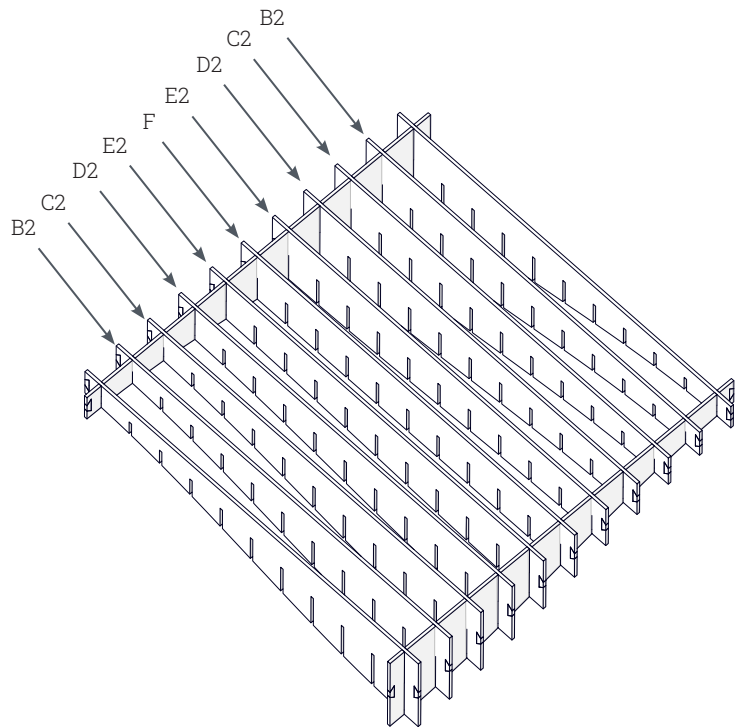

**Step 2:** Assemble the "2" variant fins inside the frame.

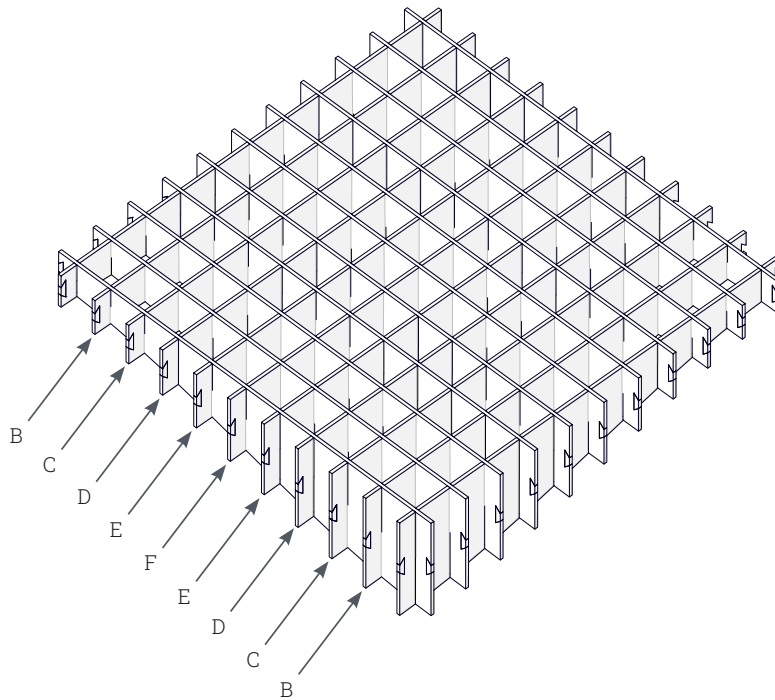

**Step 3:** Complete the module by assembling the remaining fins.

## NET: ASSEMBLY INSTRUCTION

### HARDWARE ASSEMBLY

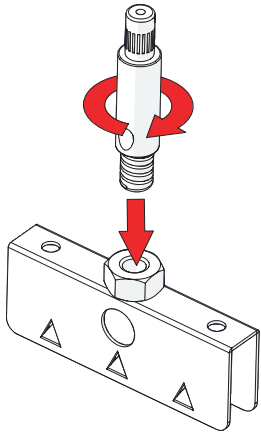

**A:** Fasten the gripper to the bracket.

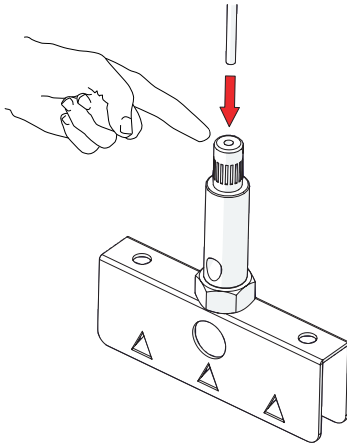

**B:** Press down on the nipple while inserting the cable end. Releasing the nipple locks the cable in place

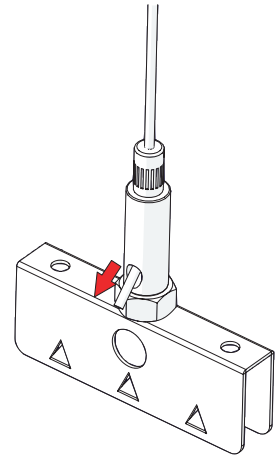

**C:** Ensure the cable threads through the side opening. Use the locking mechanism to adjust the level of NET, then trim the excess cable

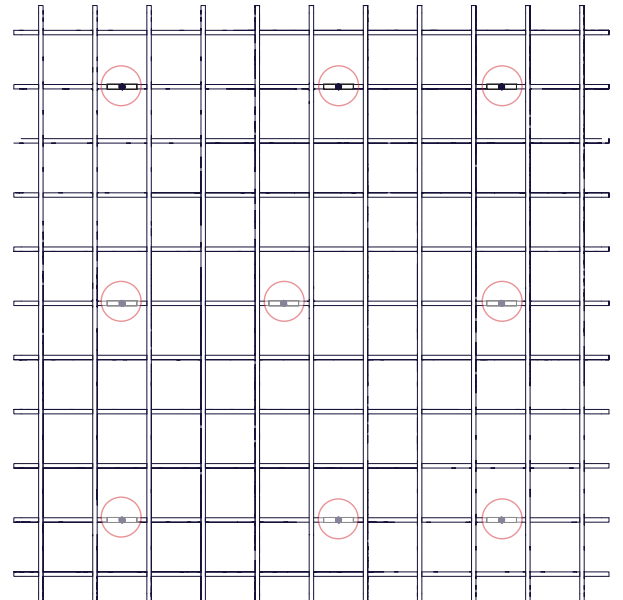
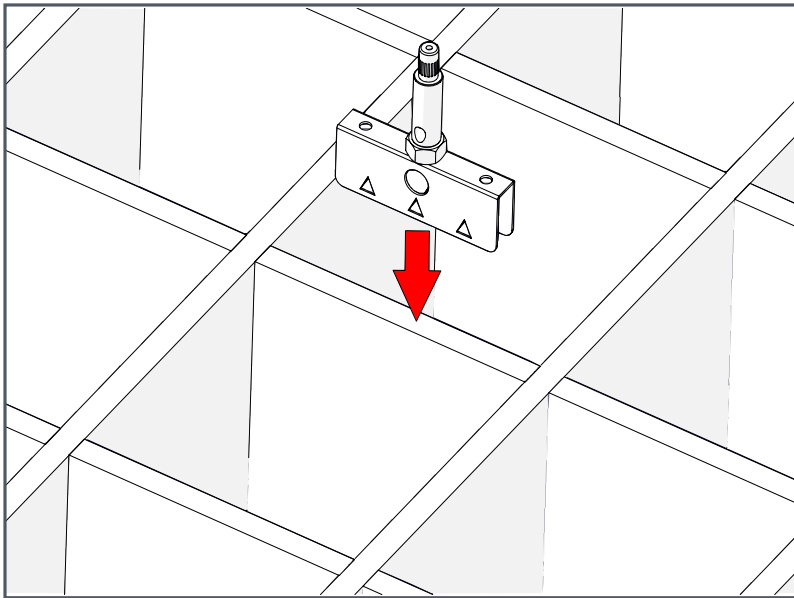

**D:** Press the brackets firmly into the fin positions shown in the diagram above. The bracket must be evenly spaced between the fins.

## NET: INSTALLATION INSTRUCTION

### CEILING MOUNT LOCATION

Use this diagram as a reference to install mounting hardware in the ceiling. This is for 4 joined modules.

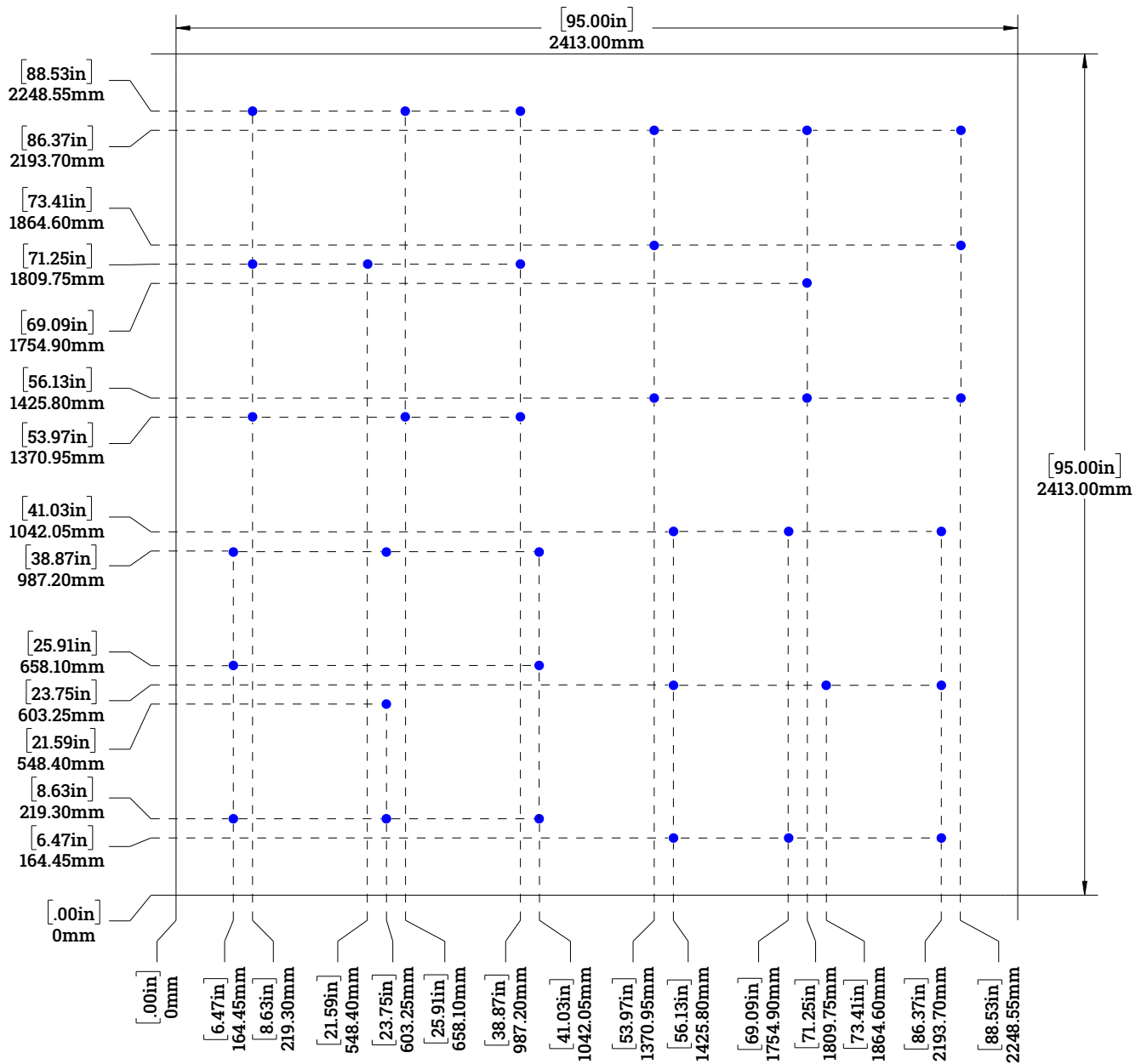

## NET: ASSEMBLY INSTRUCTION

### CONNECTING THE MODULES

**Step 4:** Remove the inserts from the ends of the fins. Hang and level the first module.

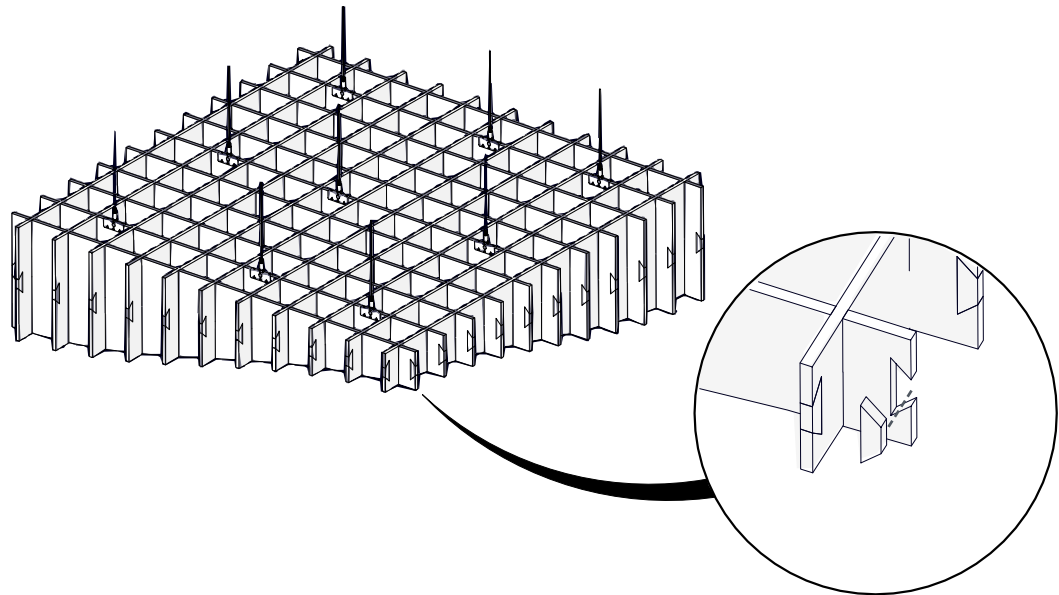

**Step 5:** Hang and level the second module. Use the bowtie connectors to join each fin at the seam.

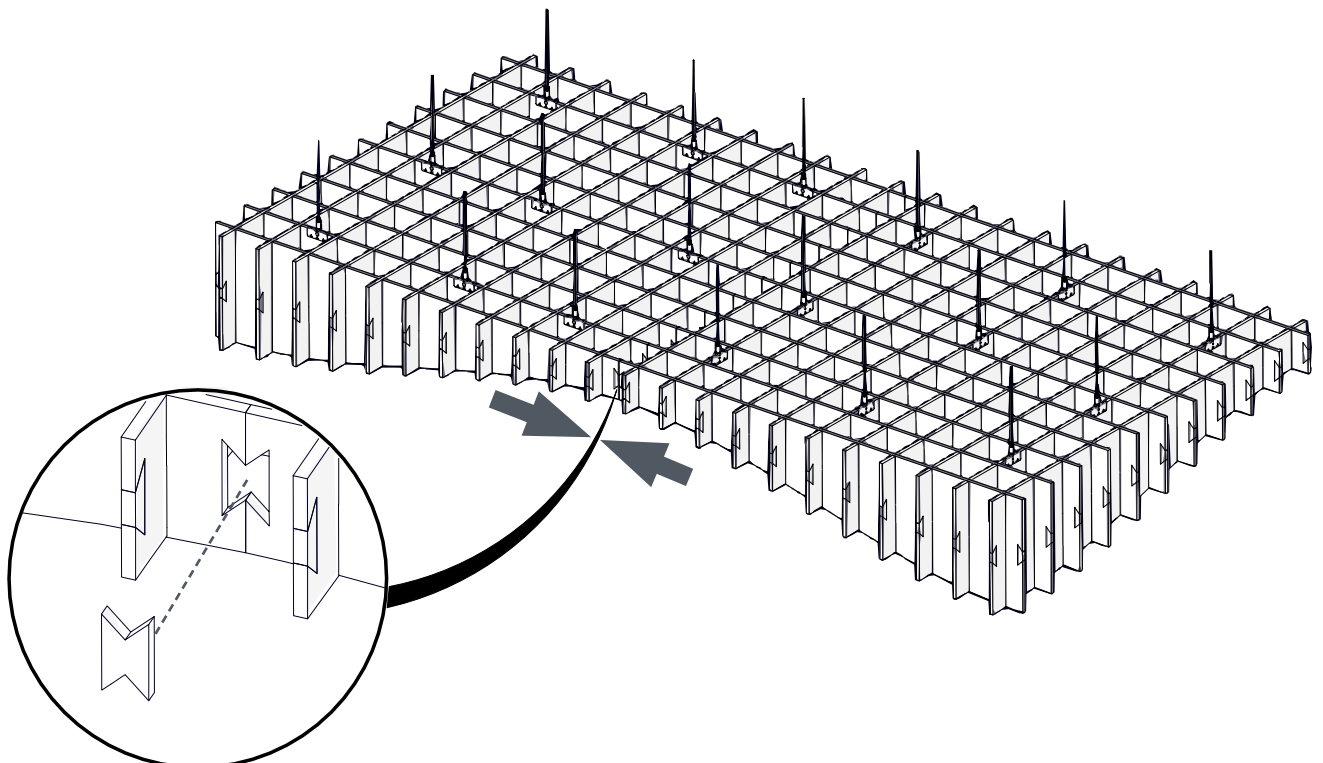



## NET: ASSEMBLY INSTRUCTION

### CONNECTING THE MODULES

---

Step 6: Connect the remaining modules.

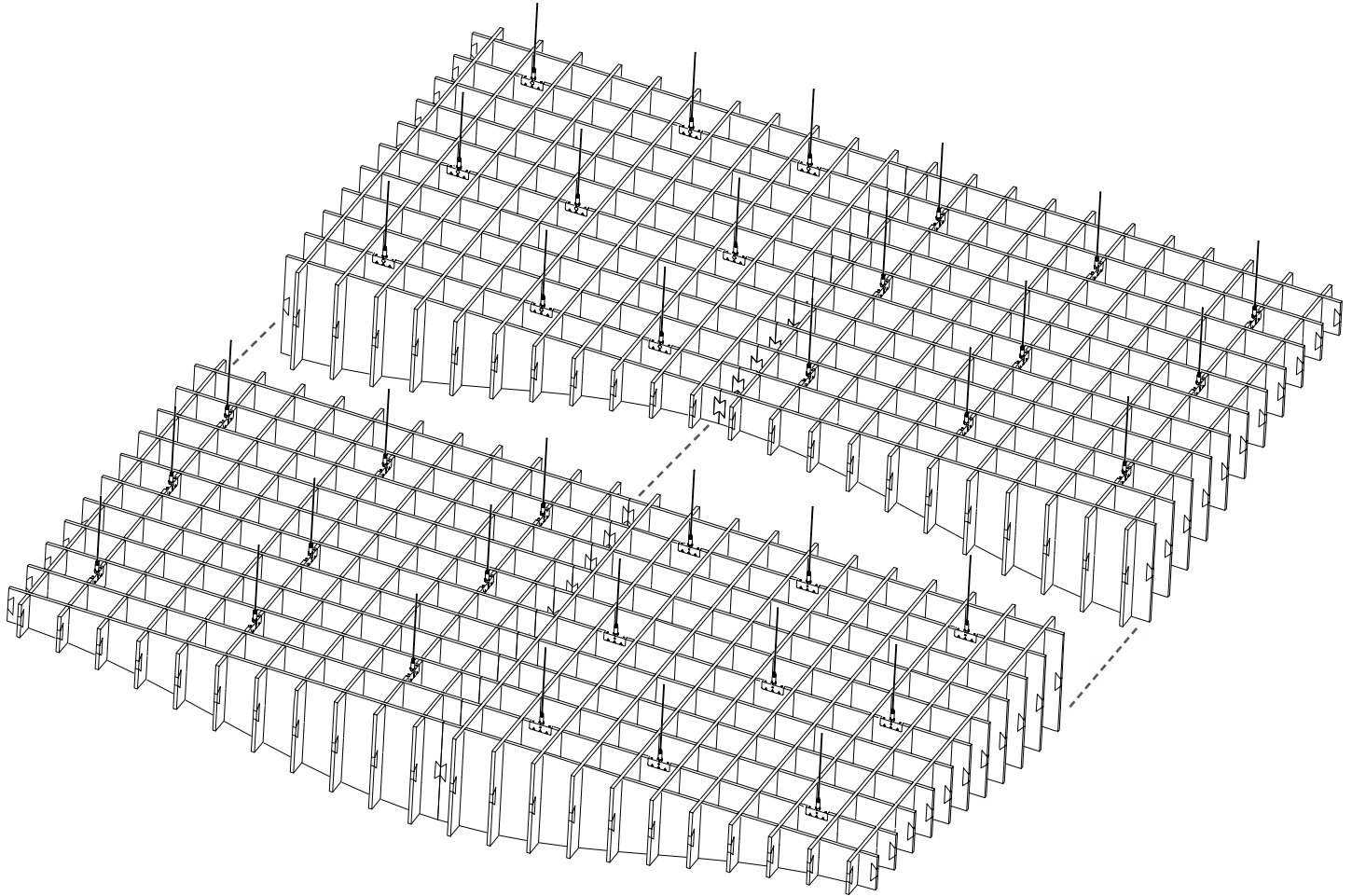

## NET: ASSEMBLY INSTRUCTION

---

### INSTALLATION COMPLETE

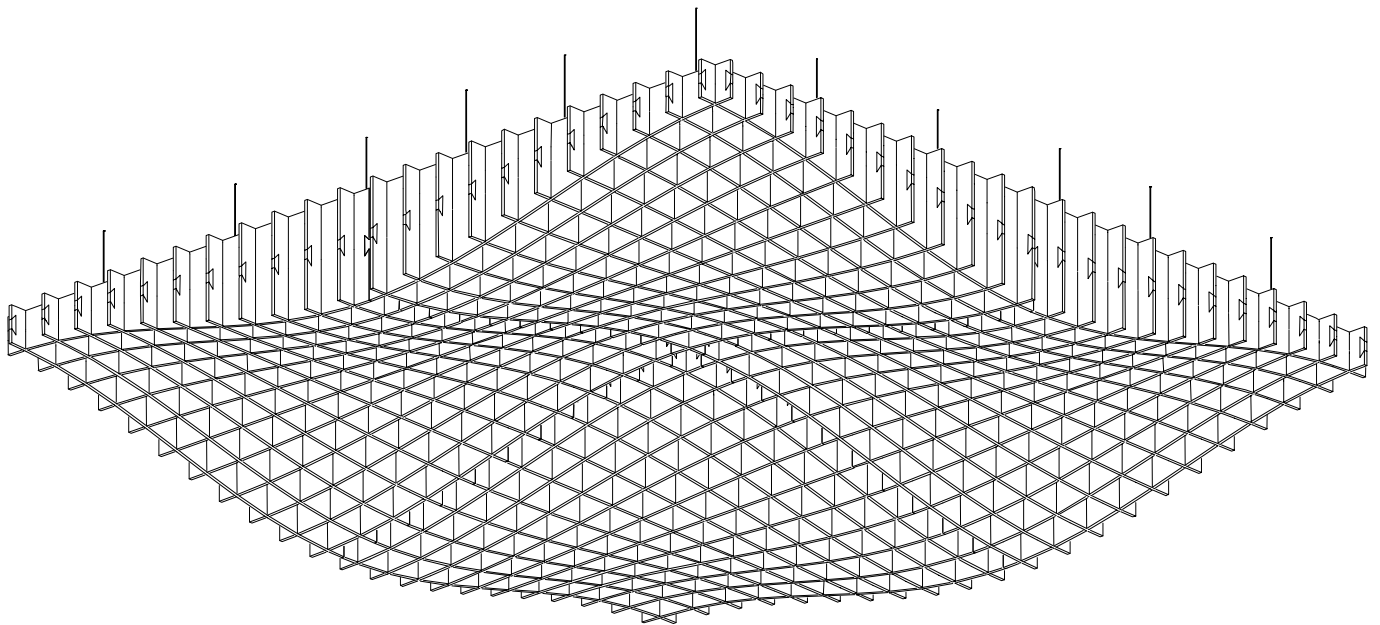
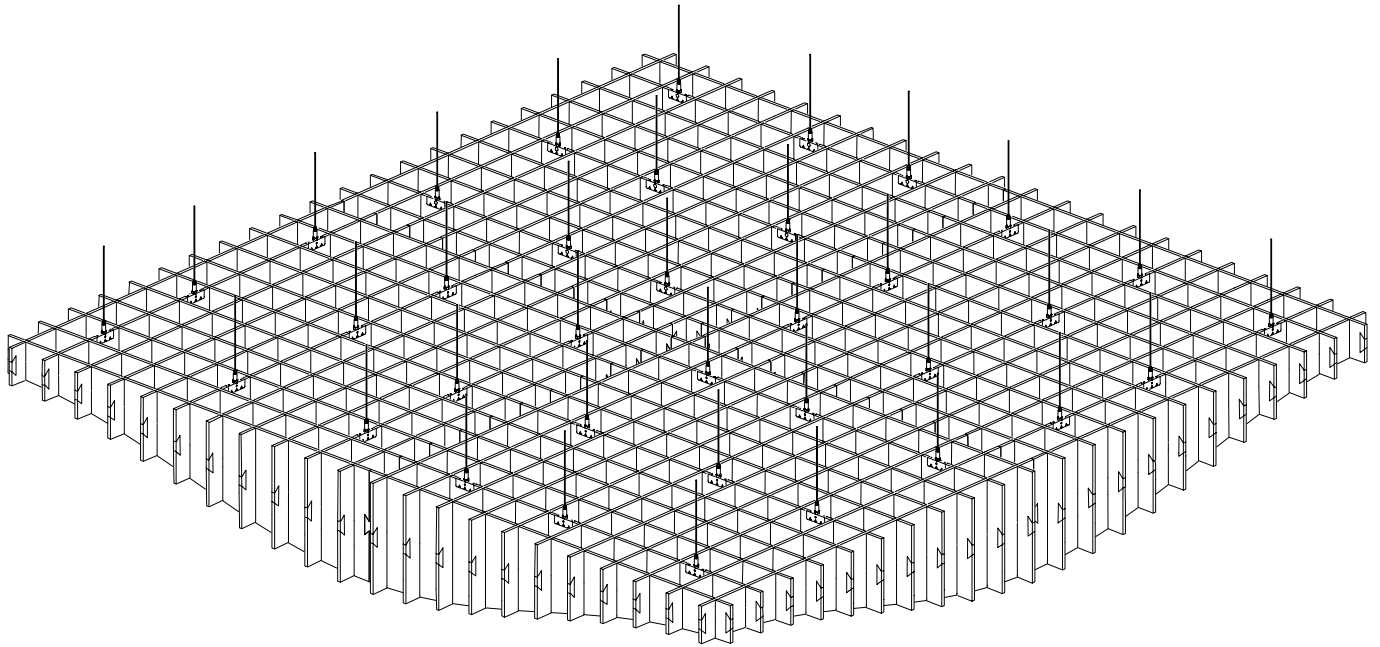

For questions, concerns or help with installation,  
contact [support@fräsch.com](mailto:support@fräsch.com)