



PANL

Fräsch was founded on the belief that creating healthy and beautiful office environments leads to a happier and highly motivated workforce.



PANL

PET Felt Screens

The PANL walls create a visual and acoustical division for your space. The pattern allows light to go through while providing an acoustical value and privacy. These free-flowing screens are a fantastic way to divide a space, add acoustical properties, and allow for endless possibilities to personalize with perforation styles.

Application Room Divider

	L	W	H	WEIGHT
PANL	48"	.35"	96"	1.02 lbs.

Custom sizing available

Custom perforated and print options available

Hardware

Default: Spike Bracket, Aircraft Cable/Threaded Rod, Coupler Nut, Griplock, Hanger Bolt

Unistrut*: Unistrut, Cone Nut Assembly, Threaded Rod/Aircraft Cable, Coupler Nut, Griplock

* Available Upon Request

Material Content 9 mm 100% PET (55% recycled content)

Flammability ASTM E84 Class A or B

Acoustics

Frequency (Hz)	250	500	1K	2K	NRC
NRC	0.35	0.54	0.85	1.22	0.75
Sabins per m²	1.40	2.17	3.39	4.89	

Test was conducted while product was in its actual installation setting

All NRC testings assumes one face/one object and does not account for the product thickness

Environment

Low VOC;
Post-Consumer Recycled Content
100% Recyclable

Installation

PANL comes with two perfectly placed and pre-installed T-Nuts for easy connectivity and quick install. Threaded Rod, Coupling Nut and Cable Grippers are included. The ceiling fastener is provided by an installer based of a ceiling type.

Country of Origin

USA

Warranty

2 Years

PANL

Dimensions & Hardware Detail

PANL Dimensions

Standard

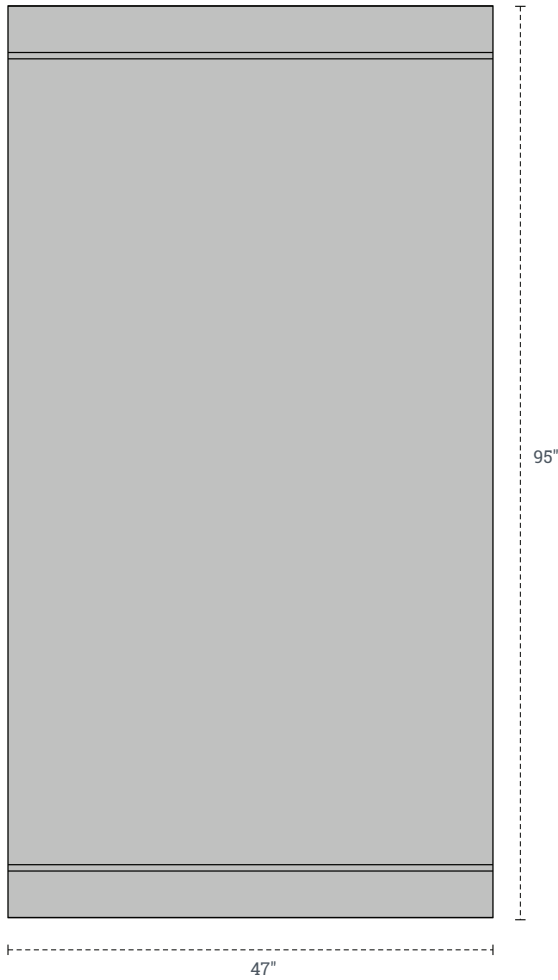

Custom

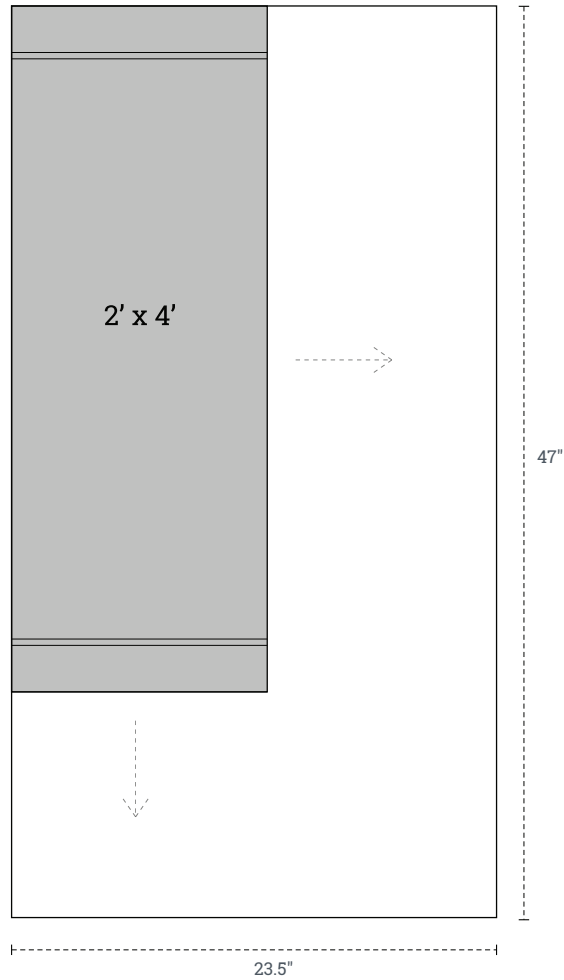

** Custom Widths from 2' to 4'
 ** Custom Heights from 2' to 8'

* Two-year limited warranty guarantees all of our products are free from defects in the materials and maintain their quality of craftsmanship. See our two-year warranty sheet for full details.

PANL

Dimensions & Hardware Detail

Aircraft Cable

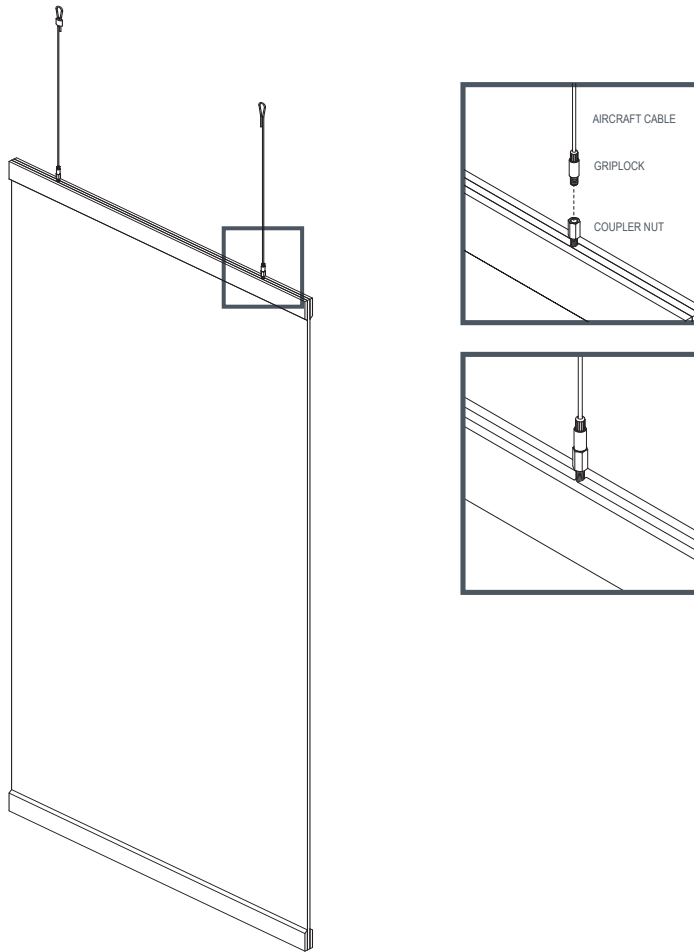

* Two-year limited warranty guarantees all of our products are free from defects in the materials and maintain their quality of craftsmanship. See our two-year warranty sheet for full details.

PANL

Dimensions & Hardware Detail

Spike Bracket

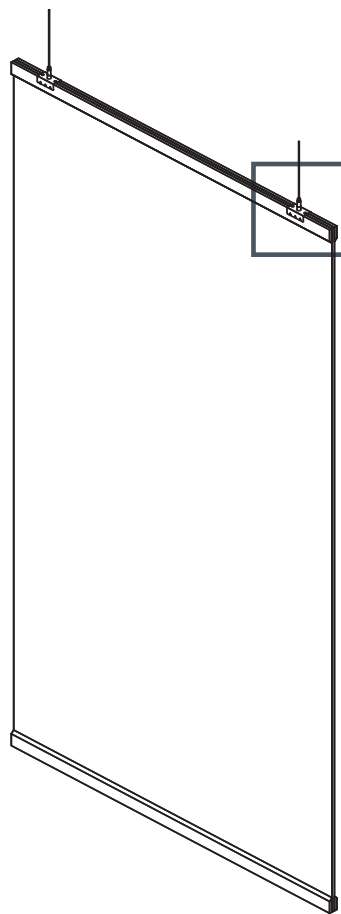

27mm Spike Bracket

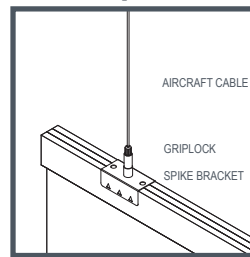

9mm Spike Bracket

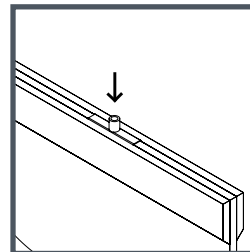
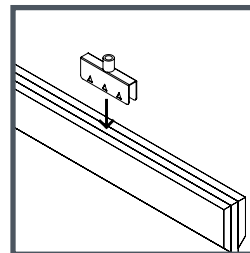

* Two-year limited warranty guarantees all of our products are free from defects in the materials and maintain their quality of craftsmanship. See our two-year warranty sheet for full details.

PANL

Dimensions & Hardware Detail

Magnetic Connectors

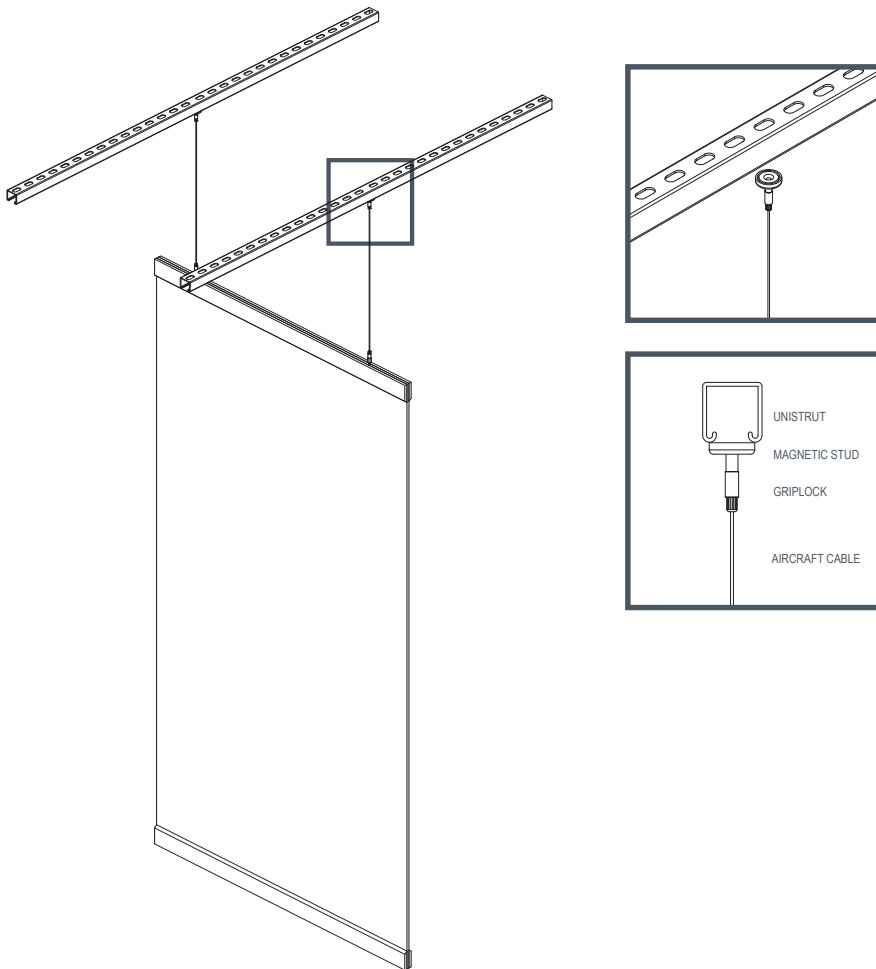

PANL

Dimensions & Hardware Detail

Conduit Clip

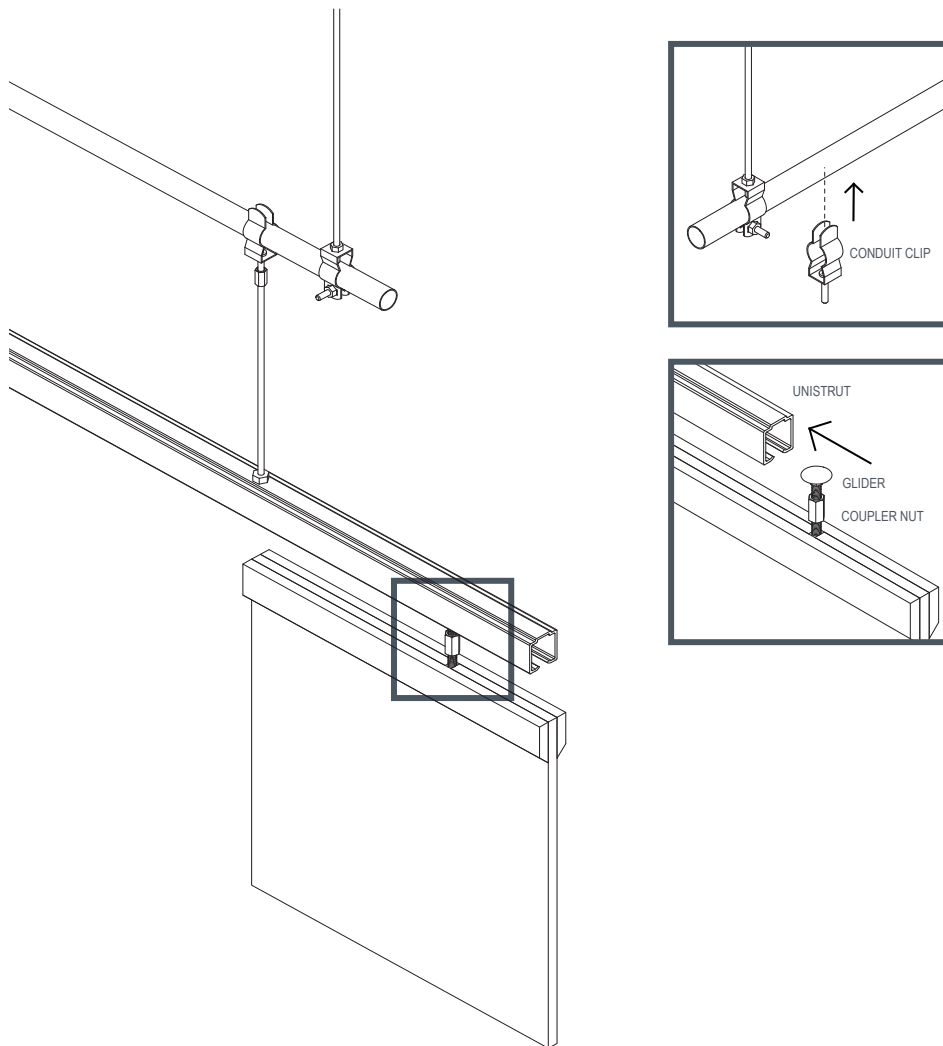

* Two-year limited warranty guarantees all of our products are free from defects in the materials and maintain their quality of craftsmanship. See our two-year warranty sheet for full details.

PANL

Dimensions & Hardware Detail

Suspended

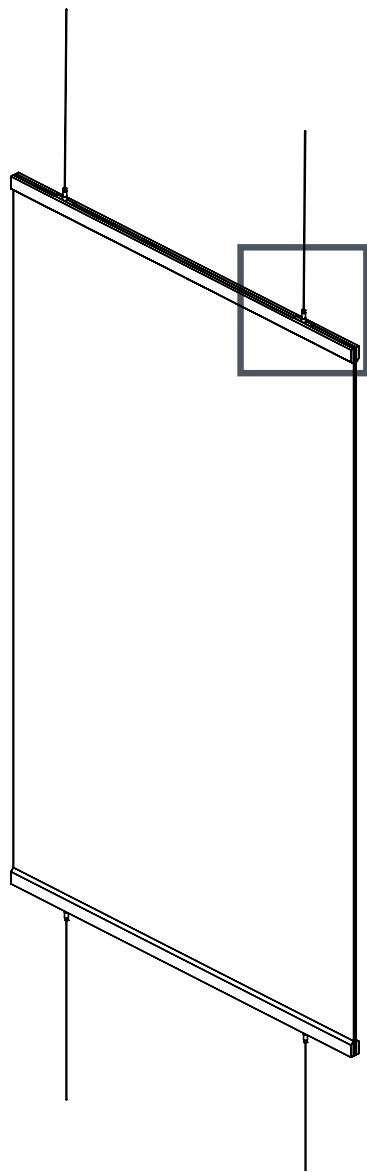

Aircraft Cable

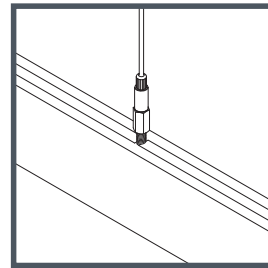
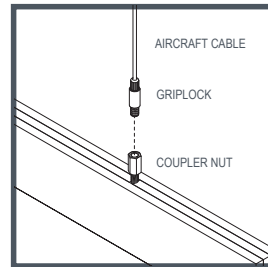

9mm Spike Bracket

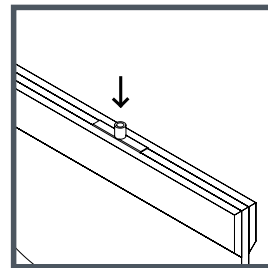
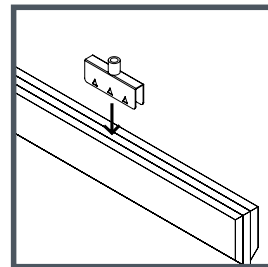

PANL

Dimensions & Hardware Detail

Hanging Aluminum Channel

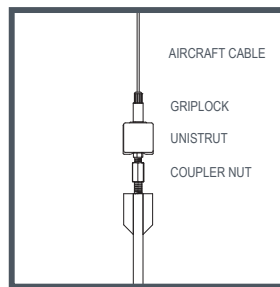
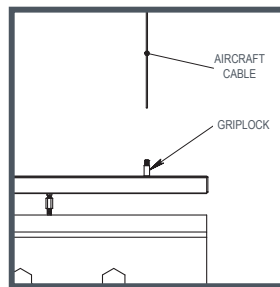
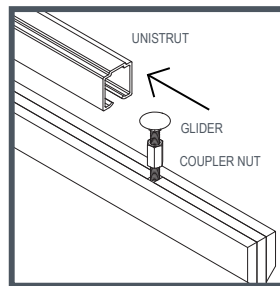
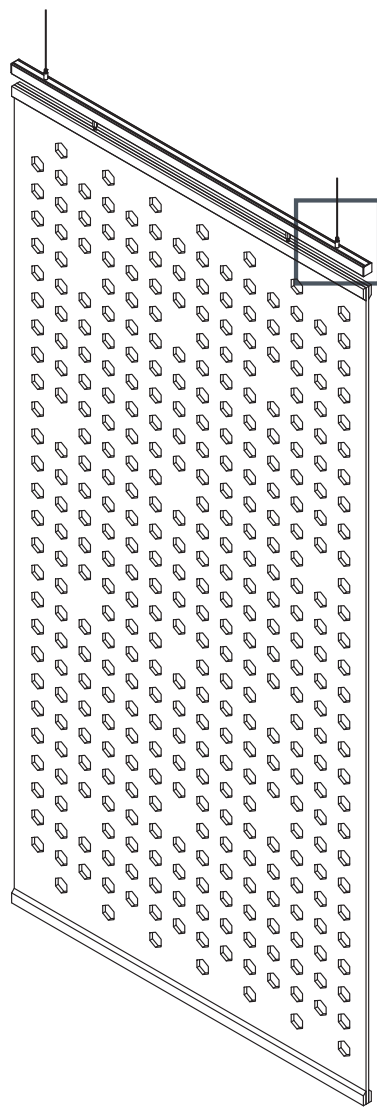

* Two-year limited warranty guarantees all of our products are free from defects in the materials and maintain their quality of craftsmanship. See our two-year warranty sheet for full details.

PANL

Dimensions & Hardware Detail

T-Grid

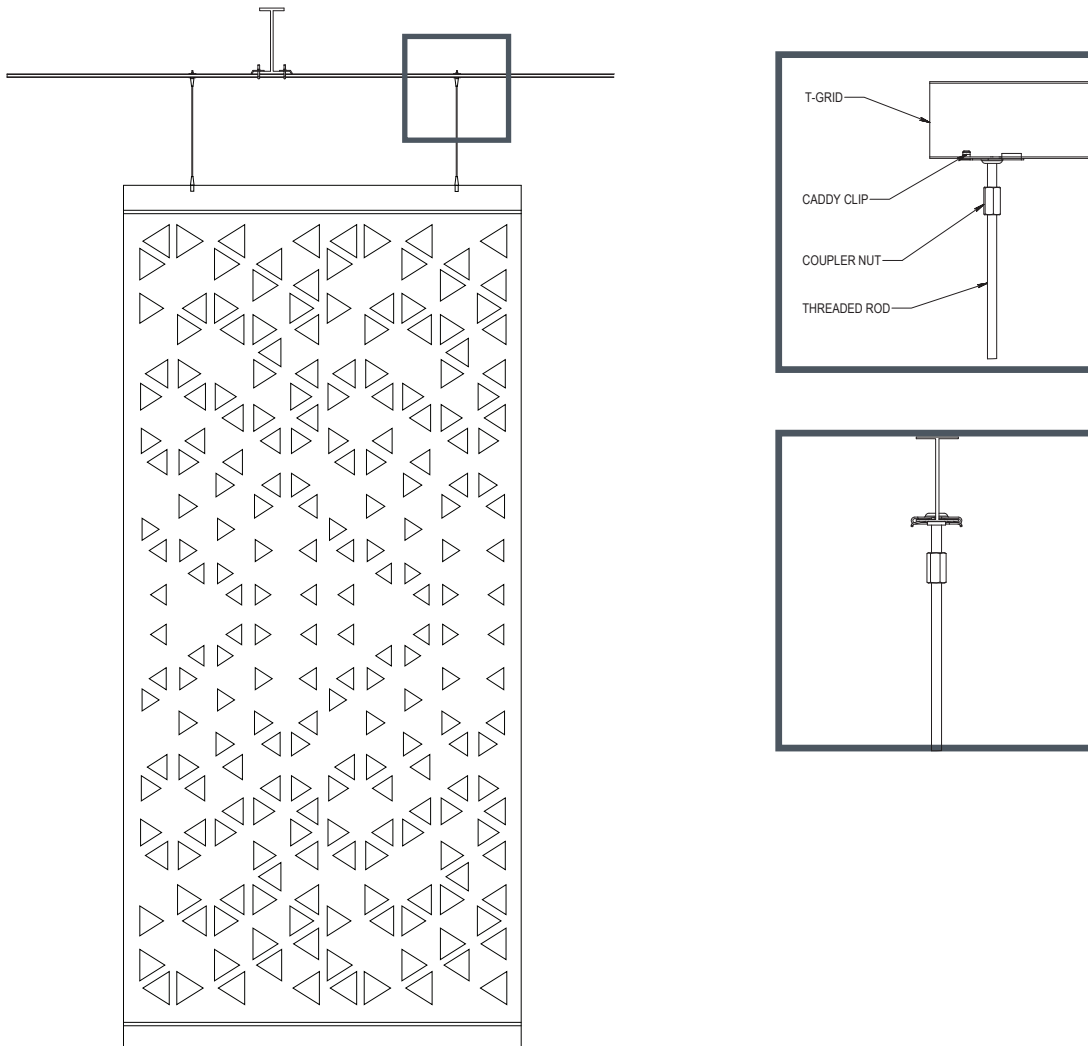

PANL

Dimensions & Hardware Detail

Track System

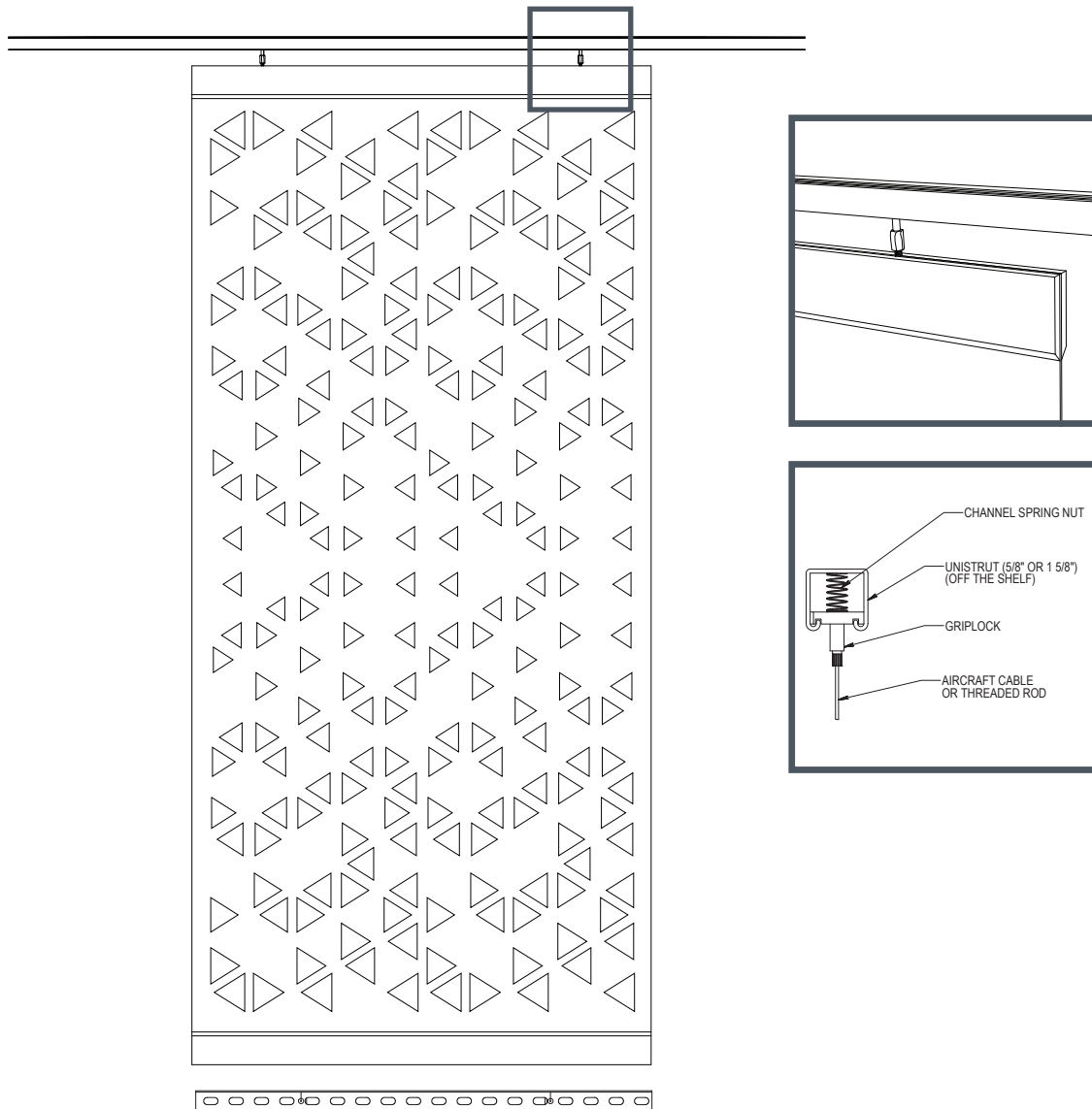

* Two-year limited warranty guarantees all of our products are free from defects in the materials and maintain their quality of craftsmanship. See our two-year warranty sheet for full details.