

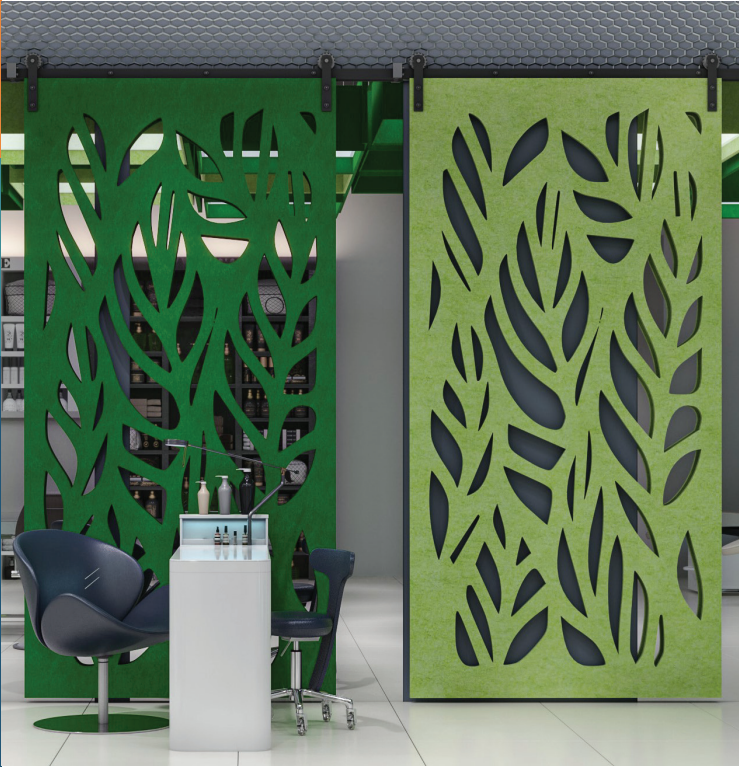

## PANL

Fräsch was founded on the belief that creating healthy and beautiful office environments leads to a happier and highly motivated workforce.



# PANL

## PET Felt Screens

The PANL walls create a visual and acoustical division for your space. The pattern allows light to go through while providing an acoustical value and privacy. These free-flowing screens are a fantastic way to divide a space, add acoustical properties, and allow for endless possibilities to personalize with perforation styles.

**Application** Room Divider

	L	W	H	WEIGHT
<b>PANL</b>	48"	.35"	96"	1.02 lbs.

Custom sizing available

Custom perforated and print options available

### Hardware

Default: Spike Bracket, Aircraft Cable/Threaded Rod, Coupler Nut, Griplock, Hanger Bolt

Unistrut\*: Unistrut, Cone Nut Assembly, Threaded Rod/Aircraft Cable, Coupler Nut, Griplock

\* Available Upon Request

**Material Content** 9 mm 100% PET (55% recycled content)

**Flammability** ASTM E84 Class A or B

### Acoustics

Frequency (Hz)	250	500	1K	2K	NRC
<b>NRC</b>	0.35	0.54	0.85	1.22	<b>0.75</b>
<b>Sabins per m<sup>2</sup></b>	1.40	2.17	3.39	4.89	

Test was conducted while product was in its actual installation setting

All NRC testings assumes one face/one object and does not account for the product thickness

### Environment

Low VOC;  
Post-Consumer Recycled Content  
100% Recyclable

### Installation

PANL comes with two perfectly placed and pre-installed T-Nuts for easy connectivity and quick install. Threaded Rod, Coupling Nut and Cable Grippers are included. The ceiling fastener is provided by an installer based of a ceiling type.

### Country of Origin

USA

### Warranty

2 Years

**fräsch!**

609 112th Street, Suite A  
Arlington, TX 76011

## 9 mm PET Felt

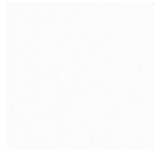

07  
White



44  
Ivory



42  
Cream



52  
Latte



53  
Smoky Beige



02  
Taupe



35  
Speckled Earth



49  
Brunette



54  
Espresso



45  
Big Red



43  
Lava



36  
Berry



50  
Caramel



41  
Marigold



55  
Tangerine



51  
Sunkist Orange

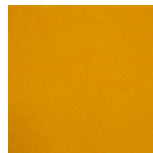

22  
Yellow



39  
Green Apple



48  
Avocado



12  
Moss



05  
Dark Green

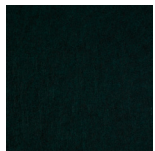

47  
Emerald



18  
Arctic Ice



30  
Blue



56  
Azure



19  
Denim



21  
Indigo Blue

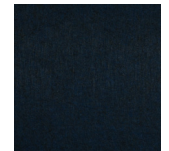

09  
Deep Blue

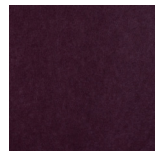

08  
Eggplant



03  
Light Gray

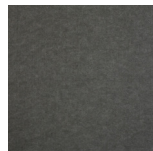

34  
Pure Gray

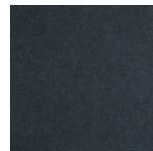

11  
Steel

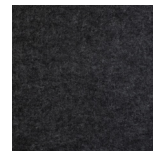

17  
Dark Gray

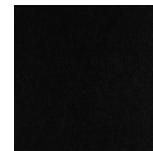

10  
True Black

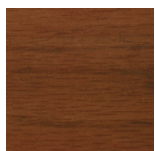

02P  
Pecan Medium  
Brown\*

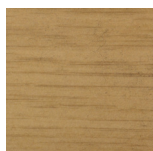

01P  
Birch Light  
Brown\*

\* \$6.00 / LF upcharge for  
Pecan Medium Brown  
& Birch Light Brown PET.

\*\* Printed options incur an extra charge.

Slight variation in thickness, fiber mix and color tones as well as heathered effect and other slight surface blemishes are an inherent feature of this product and are unavoidable. A slight color and thickness variation from batch to batch may occur. Color balance on monitors and printers vary; please request a color sample for the most accurate representation of colors.

## PANL

# Dimensions & Hardware Detail

### PANL Dimensions

Standard

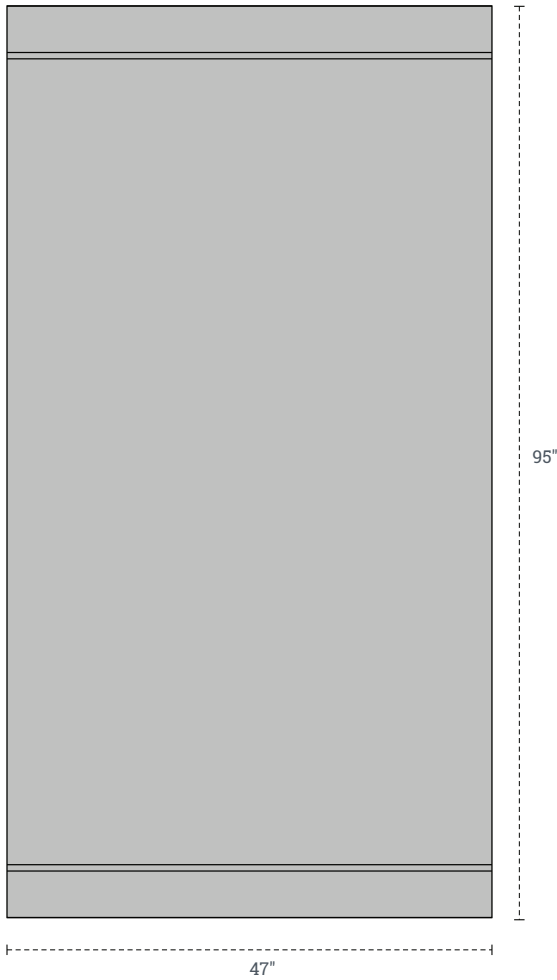

Custom

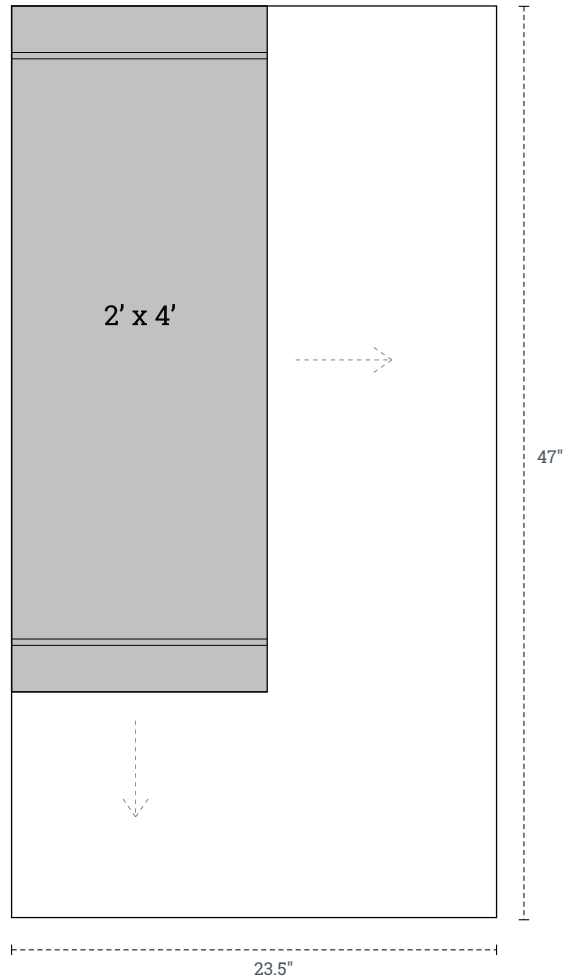

\*\* Custom Widths from 2' to 4'  
\*\* Custom Heights from 2' to 8'

## PANL

# Dimensions & Hardware Detail

---

### Aircraft Cable

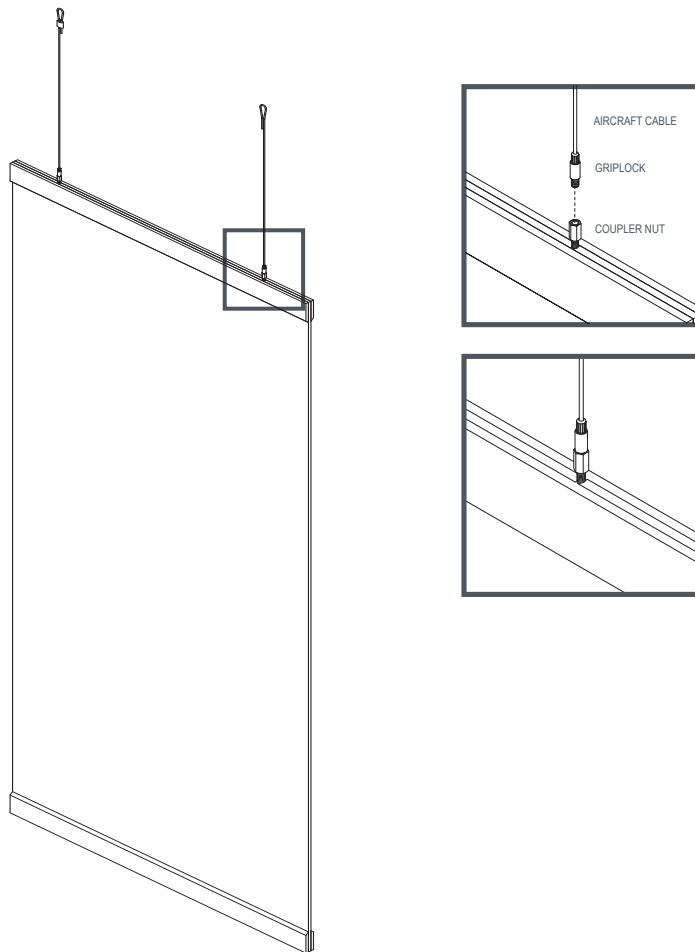

## PANL

# Dimensions & Hardware Detail

---

### Spike Bracket

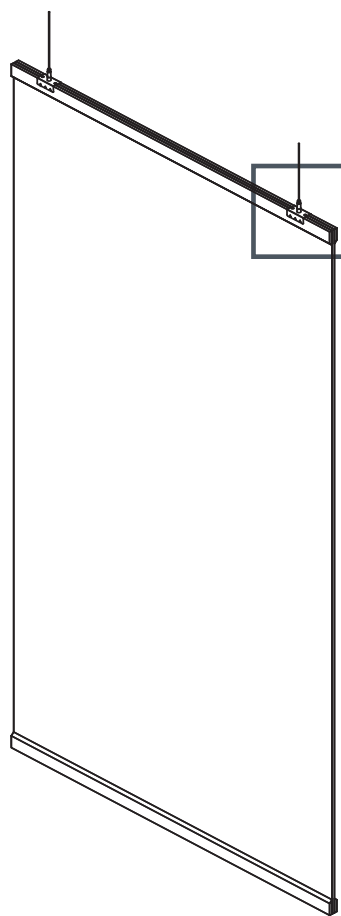

27mm Spike Bracket

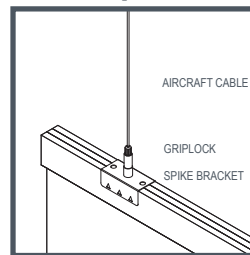

9mm Spike Bracket

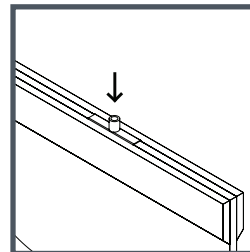
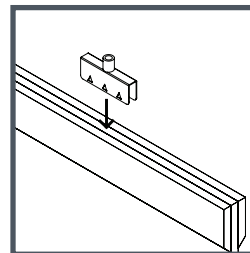

## PANL

# Dimensions & Hardware Detail

---

### Magnetic Connectors

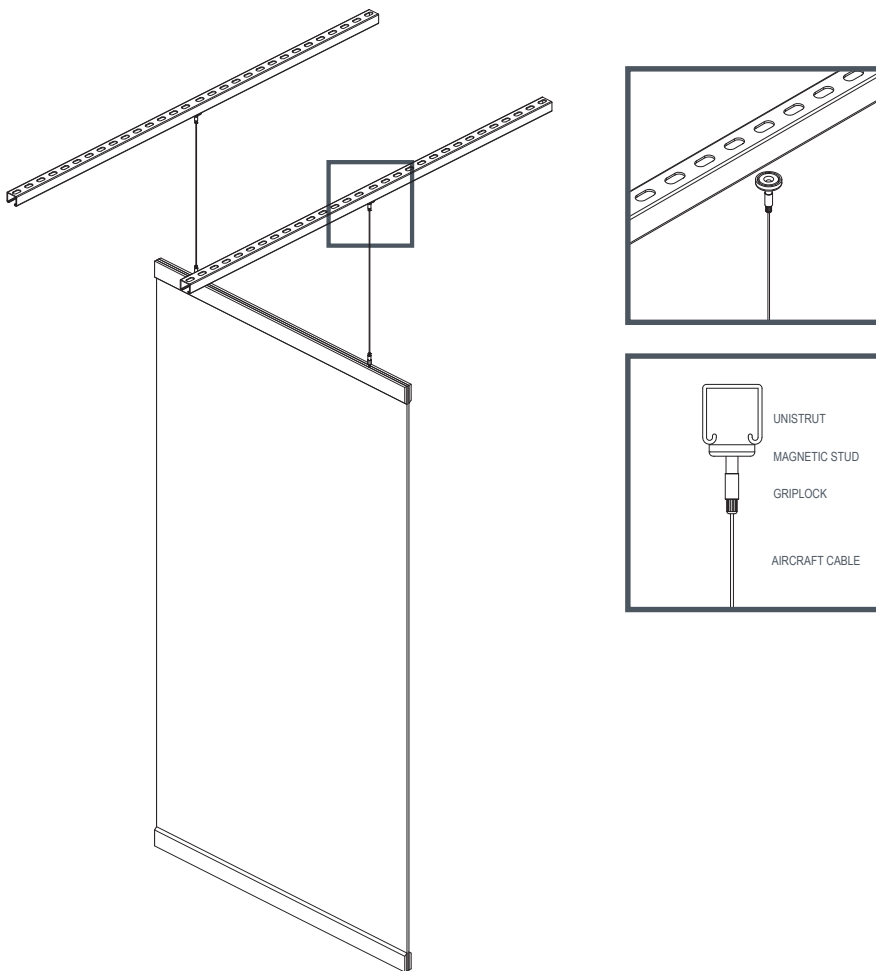

## PANL

# Dimensions & Hardware Detail

### Conduit Clip

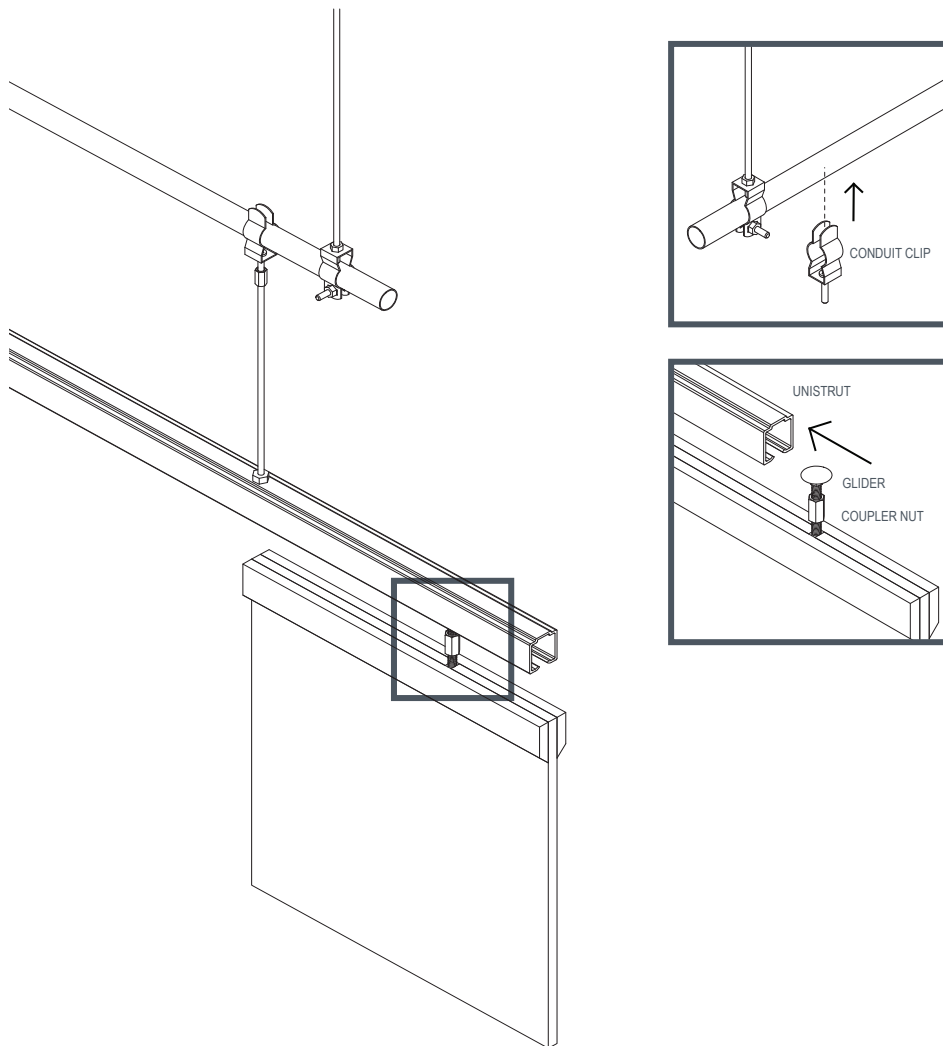



## PANL

# Dimensions & Hardware Detail

---

### Suspended

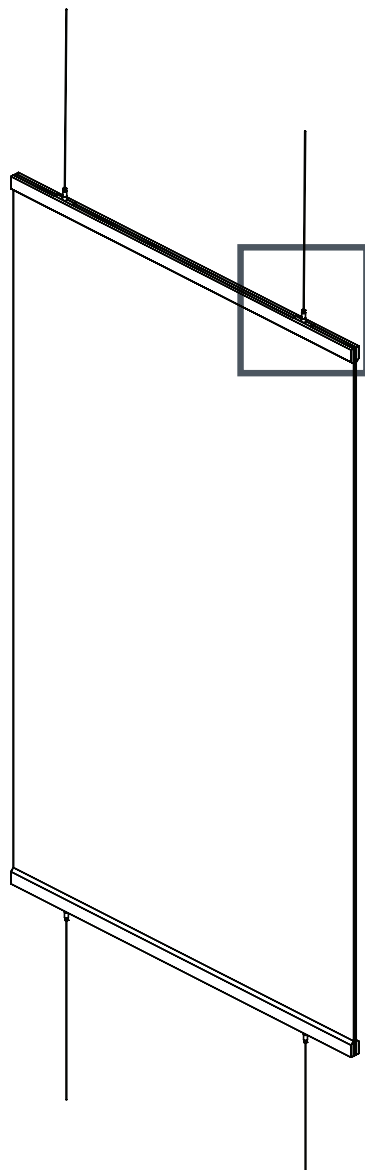

### Aircraft Cable

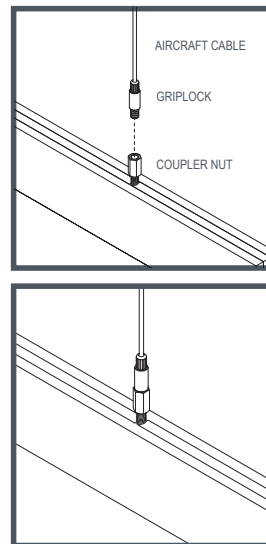

### 9mm Spike Bracket

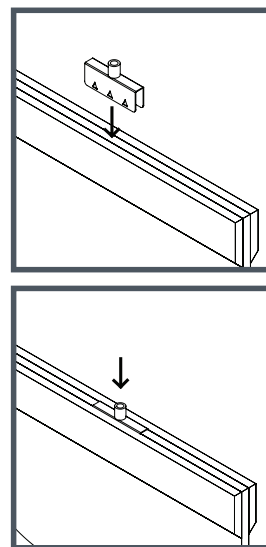

## PANL

# Dimensions & Hardware Detail

### Hanging Aluminum Channel

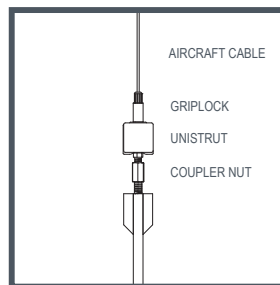
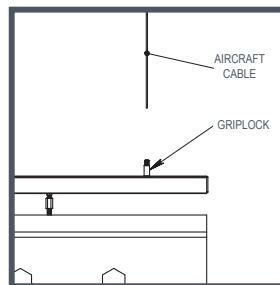
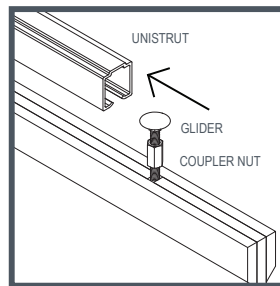
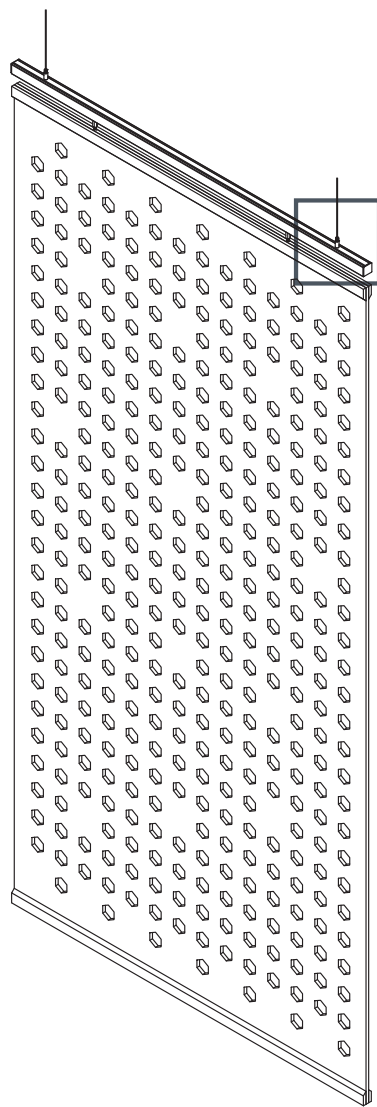

## PANL

# Dimensions & Hardware Detail

---

### T-Grid

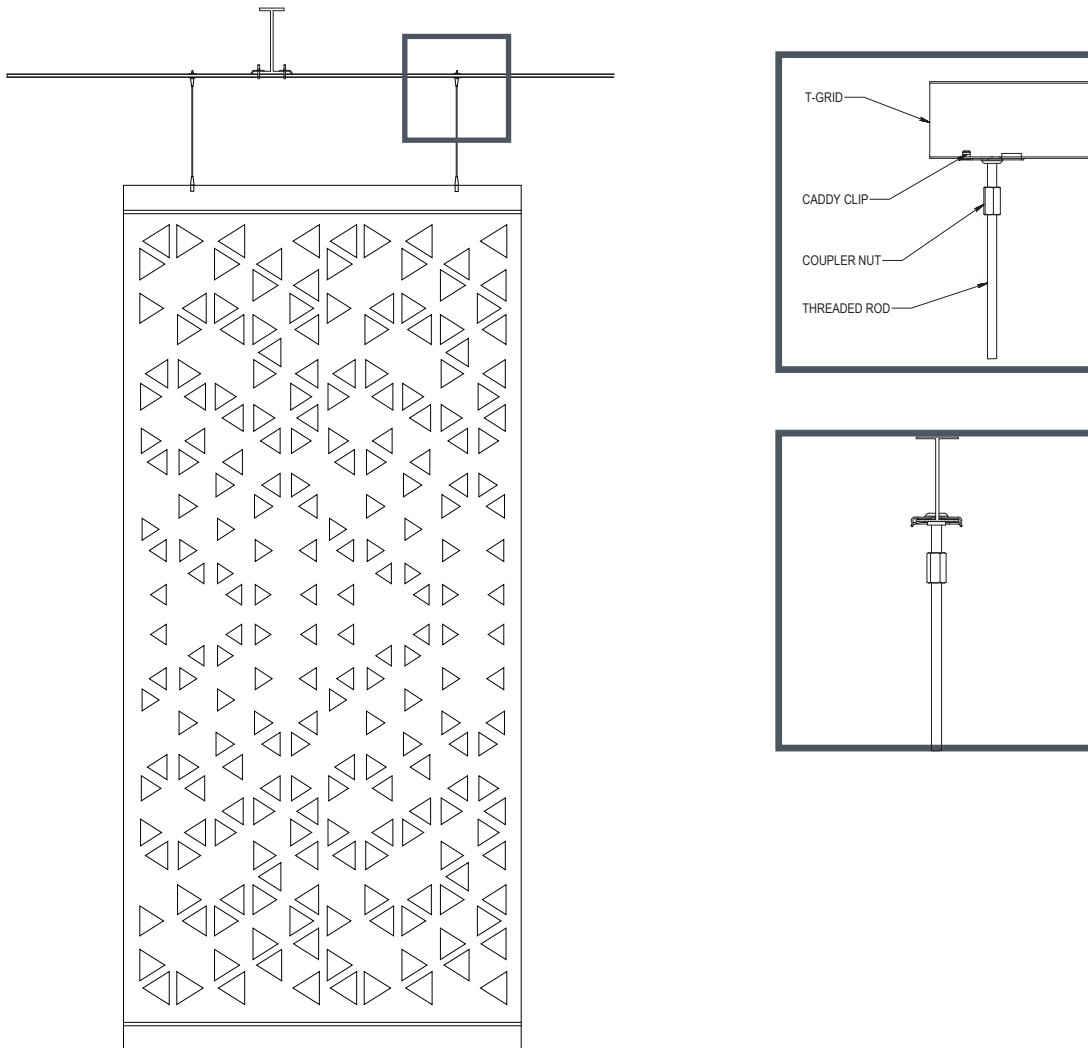

## PANL

# Dimensions & Hardware Detail

### Track System

